

# Development of a Low Cost Spectrometer for Small Radio Telescope (SRT), Very Small Radio Telescope (VSRT), and Ozone Spectrometer

August 9, 2013

Marc Higginson-Rollins  
University of Kentucky  
Lexington, KY

Dr. Alan E.E. Rogers  
MIT Haystack Observatory  
Westford, MA

**Abstract**— Several instruments used for education, outreach and scientific investigations could benefit from a low cost spectrometer. These include the Small Radio Telescope known as the "SRT", a very small radio telescope known as the "VSRT", and an 11 GHz Ozone spectrometer. The SRT is used to observe the Sun and the 21-cm hydrogen line. The SRTs, which until recently were available commercially, are still in operation at many universities and are used for student projects including measuring the Galactic rotation curve of our Galaxy. These instruments, which were initially primarily used to help teach students how to analyze scientific data, are now used for scientific investigations that have resulted in publications in science journals. Recently a low cost USB "dongle" for digital TV has become available. It has been adapted for use as a software defined radio by amateur radio groups. Linux-based software was developed to adapt the device to form a low cost digital spectrometer for the SRT by integrating open source code into the existing C code written for the SRT. Some challenges faced when trying to integrate the USB TV dongle into the SRT system and software will be discussed. To test the effectiveness of the USB TV Dongle based SRT several astronomical observations were made and compared to the older SRT system. These observations show promise for the device replacing older SRT systems at a fraction of the cost and effort and as a possible replacement for the VSRT and Ozone spectrometer. (*Abstract*)

**Index Terms**—SRT, VSRT, spectrometer, low cost, Ozone. (*key words*)

## I. INTRODUCTION

The Small Radio Telescope known as the "SRT", the very small radio telescope known as the "VSRT", and the 11 GHz Ozone spectrometer represent several scientific instruments used for education, outreach, and scientific investigations that have been widely popular but remain relatively high cost to build. Despite the new SRT built in the summer of 2012 at MIT's Haystack Observatory, the complexity and cost of building an SRT still remains high. The recent availability of

USB TV dongles and their subsequent adaptation by various amateur radio groups to be used as software defined radios represents an opportunity to adapt the TV dongles to be used as the spectrometer for the SRT, VSRT, and Ozone spectrometer. This document will outline the testing and analysis of a USB TV Dongle as a potential candidate for use as spectrometer, the subsequent results and difficulties faced, and astronomical observations made using the TV dongle as the spectrometer for the SRT with comparisons to previous work using the SRT developed in 2012 at the MIT Haystack Observatory.

## II. OVERVIEW OF THE SYSTEM

The DVB-T Dongle being used is composed of the Rafael R820T Tuner chip from Rafael Microelectronics, Inc. and the RTL2832U Demodulator chip from Realtek, Inc. The tuner chip is a super-heterodyne receiver that interfaces with the analog to digital converters (ADCs) in the demodulator chip. The ADCs digitize I/Q data into separate 8-bit alternating data packets up to a maximum theoretical sample rate of 3.2 MS/s and sends the data to a computer via USB. It is composed of three variable amplifiers that can be changed in code by setting register values, an RF filter, an IF filter, and a mixer stage that down converts the RF signal to an intermediate frequency. The R820T based dongle has a frequency range of 24-1766 MHz. A rough schematic of the dongle can be found in **Figure 1**. The actual tuner can be found in **Figure 2**.

Various open source groups have reverse engineered this and similar devices to operate as low cost software defined radios. When in this "SDR mode," the devices output digitize the raw I/Q data using the 8-bit ADCs, but bypass any demodulation before being sent to the PC via USB.

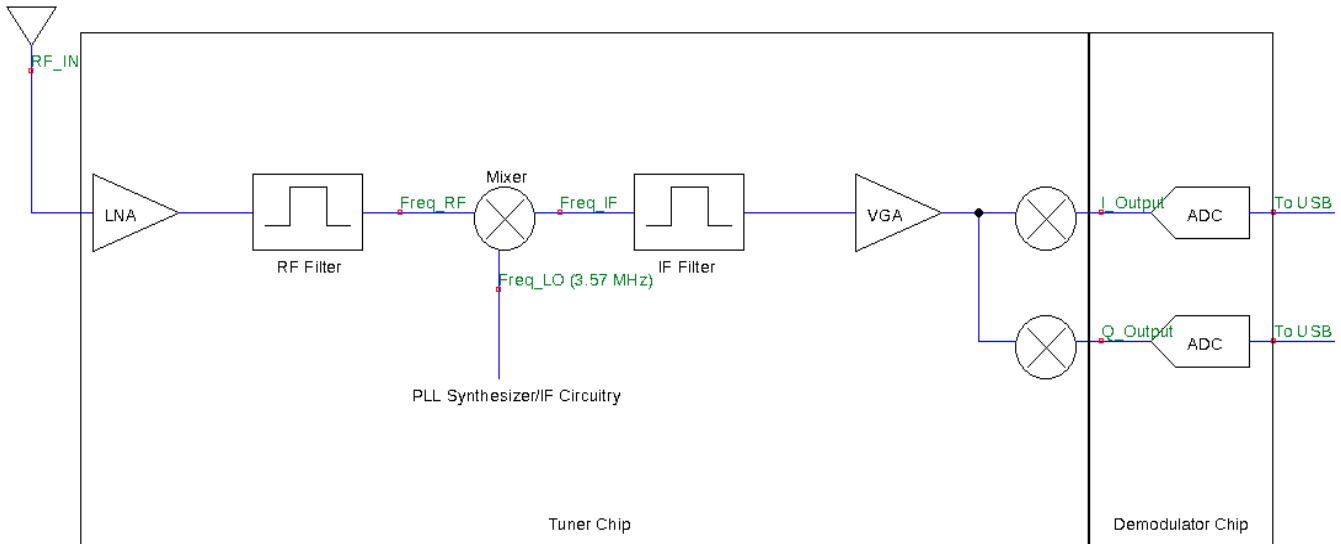

**Figure 1:** A rough schematic of the TV USB dongle.

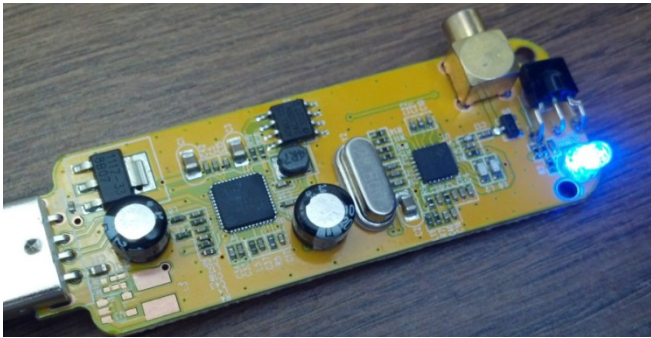

**Figure 2:** An image of the actual TV USB dongle used without its plastic covering.

To interface with the USB Dongle, the open source code RTLSDR was used, which was based on the original drivers of the device. The RTLSDR utilizes LibUSB1.0 to control aspects of the device such as frequency, amplifier gains, sample rate, etc. This code served as the basis for the later C code developed and integrated into the SRT software. The physical dongle based SRT system will be discussed in a later section.

### III. FREQUENCY DRIFTING AND OFFSET

The USB TV device utilizes a generic crystal oscillator that has no thermal control, so it is very susceptible to environmental effects. In addition, the component has an internal bias present due to the manufacturing process among other factors. To determine what effect this crystal oscillator would have on the device, several experiments were done, including: measuring the temperature difference from cold start to operating temperature of the tuner chip and the crystal oscillator, measuring the drift, if any, of the frequency, and measure any possible frequency offset. To determine if USB TV Dongle would be suitable as a replacement for the previous

SRT system, it is vital to have accurate and stable frequency tuning and recording to make accurate astronomy observations.

#### Frequency Drifting

The frequency drifting of the device is directly linked to its temperature. A simple experiment was used to test how long it took for the device to reach thermal equilibrium at room temperature. From a cold start-up, the TV Dongle was powered and tuned to 1420.4 MHz. A constant signal was feed into the device from a signal generator (HP 8648B Signal Generator) at 1420.4 MHz. The drifting of this signal was examined in two ways: first, the frequency at which the device read the input signal was examined, see **Figure 3**, and second the average power of the spectrum of the device was examined, see **Figure 4**. It should be noted, that for **Figure 4**, the random variation in the average power could be a result of RFI as for this test was done in a room with many possible noise sources present. Both values were recorded over time until the output stabilized. In addition, before and after temperatures of the tuner chip and the crystal oscillator were recorded, see **Table 1**.

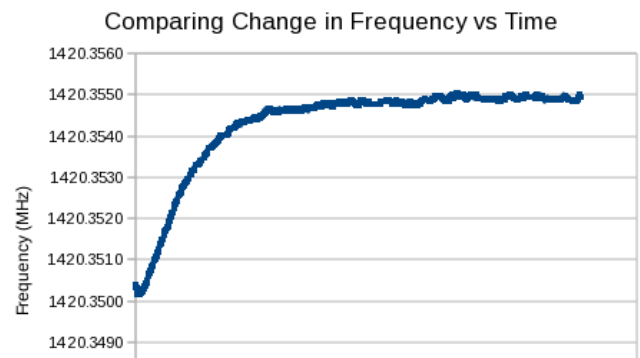

**Figure 3:** Comparing change if frequency of a measured input signal on the USB TV dongle over time from a cold start to operating temperature.

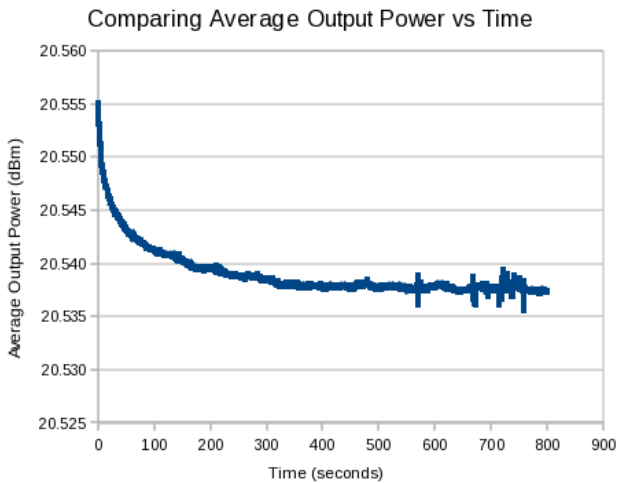

**Figure 4:** Comparing change in average spectra output power over time with a known input signal from a cold start to operating temperature.

|                          | Time (seconds) | Temperature (Celsius) |
|--------------------------|----------------|-----------------------|
| Start Tuner Chip         | 0              | 23.8                  |
| End Tuner Chip           | 750            | 48.2                  |
| Start Crystal Oscillator | 0              | 23.8                  |
| End Crystal Oscillator   | 650            | 40.6                  |

**Table 1:** Results from examining the change in temperature of the tuner (R820T) chip and the crystal oscillator from cold start to operating temperature.

From examining **Table 1**, the crystal oscillator has a temperature variation of 16.8°C and the tuner chip has a temperature variation of 24.4°C. When compared to **Figure 3 and 4**, for both components to reach the stable operating temperature it takes a time period of about 600 seconds, or ten minutes. However, once the device has stabilized thermally, there still are some fluctuations: from **Figure 3** the variations are only on the order of Hertz and from **Figure 4** the variations are on the order of thousandths of dBm. In terms of frequency drifting, the device is relatively stable at room temperature once it has reached its operating temperature, which requires roughly ten minutes, thus in terms of stability of the measurement, the USB TV dongle provides reasonable assurance that it is stable enough to observe the 21 cm Hydrogen line.

#### Frequency Offset

When examining **Figure 3**, it is evident that although the frequency stabilizes after about ten minutes of operation it is still not exactly at 1420.4 MHz. This is due to the frequency accuracy of the crystal oscillator. There is no documentation provided for the specific crystal oscillator used, however, the

R820T datasheet provides requirements for the crystal oscillator being used. The frequency accuracy given in the datasheet requires a typical value of  $\pm 30$  ppm and a maximum value of  $\pm 50$  ppm. The frequency accuracy can easily be tested using a known input signal as done in the above tests. After measuring the offset, it was found, for the specific device being used, to be  $\sim 44.4$  kHz. This correlates to a frequency accuracy of about -31.3 ppm (parts per million), which is within the specifications for the device. In addition, this error is constant when the device is at a stable operating temperature and can easily be accounted for in software. Below is a screen capture of the frequency offset before, **Figure 5**, and after correction, **Figure 6**. In both previous figures, a constant input signal from a signal generator was feed into the device at 1420.4 MHz.

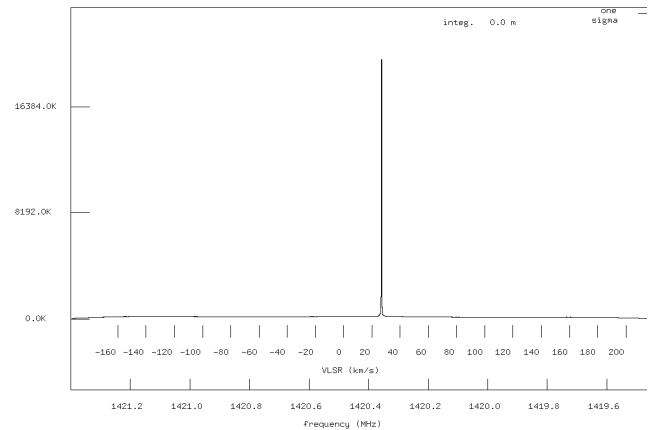

**Figure 5:** Sample spectra before the frequency offset was corrected.

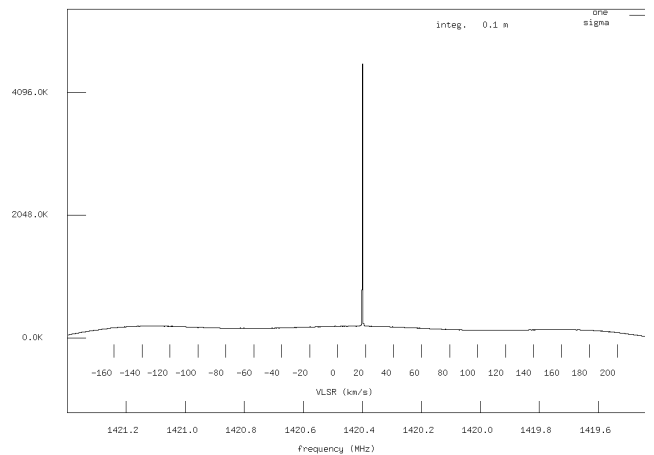
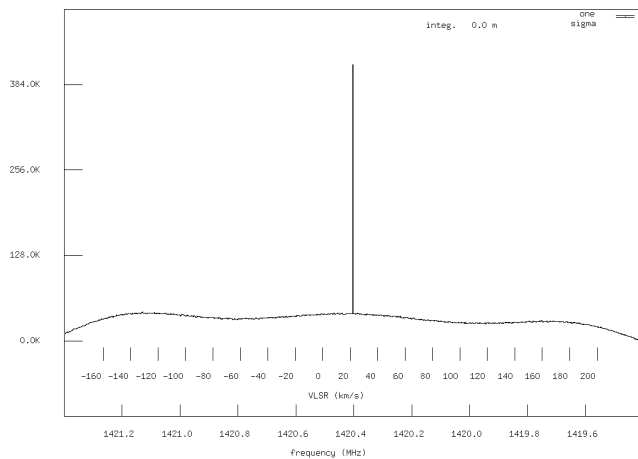

**Figure 6:** Sample spectra after the frequency offset was corrected.

#### IV. SPECTRUM BIAS CORRECTION

When examining the spectra of the USB TV Dongle a giant spur is present in the exact center of the spectrum. This spur is constant from device to device and stable over time making it very easy to measure. When averaging all the I values and Q

values for a single spectrum, each should theoretically equal zero, however, in reality both equal about 0.39 with very slight variation over time. This bias propagates when the raw data is being converted to be used. The raw 8-bit values are subtracted by 127 then converted into a double. Without correcting for this bias, the values are higher than expected. However, because this bias is stable to a few decimal places, it can be easily accounted for in software by treating it as a constant value. To correct for the bias, the raw value is subtracted by about 127.39 instead. Note the two following figures, **Figure 7** is before the bias correction, **Figure 8** is after the bias correction has been implemented. Note, neither spectrum has base band calibration and that the slight slope is due to a filter used.



**Figure 7:** Spectrum before bias correction.

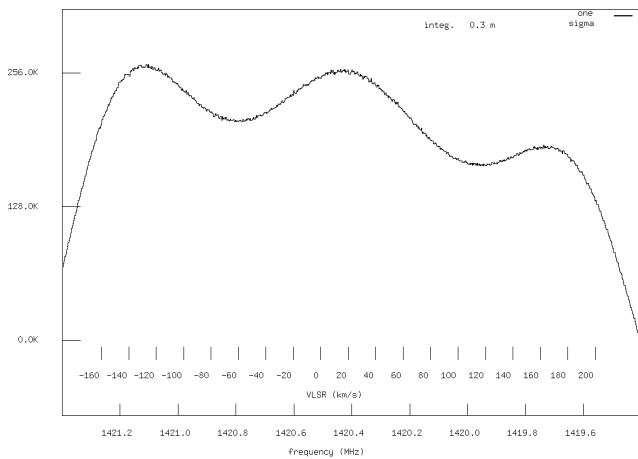

**Figure 8:** Spectrum after bias correction.

## V. GAIN AND SATURATION

In order to detect the 21 cm Hydrogen line, the dongle based SRT system must be able to detect a signal at -125 dB. After the signal enters the antenna, it receives +26 dB of gain from the Low-Noise Amplifier (LNA) [1]. Past this point, the remaining signal must be amplified from the internal variable gain amplifiers of the device itself. Experiments were done to determine the feasibility of this. For all these experiments, the auto-gain control setting was disabled and manual values were hardcoded to the three registers of each amplifier, the internal LNA, the internal Mixer Amplifier, and the VGA. The values that could be set ranged from 0-F, being that only a single hexadecimal value was controlling the gain. From testing, it was found that the internal signal was easily over saturated and that the actual gain value did not perfectly linearly correlate to the register value set. However, when the register values were set and the input signal from a function generator was varied the output line was linear as expected, see **Figure 9**. In addition, the values chosen for **Figure 9** were the values that were used to develop this SRT system. It was found that with this setting, there was a reasonable amount of internal gain provided and a reasonable range between the noise floor and the point at which saturation begins to occur.

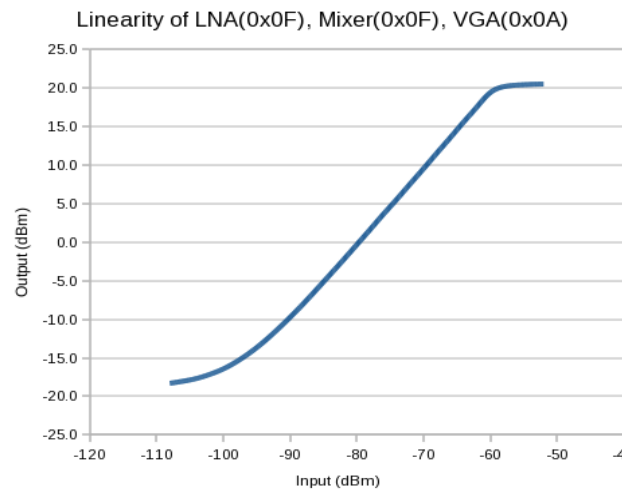

**Figure 9:** Linearity of the chosen amplifier configurations.

When the gain configuration was tested with the SRT system attached no Hydrogen line was detected. To resolve this, a line amplifier was added to provide additional gain, about +15 dB. However, when the line amplifier was added, it was soon discovered that the device was being saturated because the noise and RFI (radio frequency interference) at all frequencies were being amplified through the system. To resolve this, a filter was added after the line amplifier, this will be discussed more later.

## VI. RFI (RADIO FREQUENCY INTERFERENCE)

RFI, or radio frequency interference, was a huge issue due to the proximity of the testing site to the nearby Millstone Hill

Radar, which operates at 1295 MHz. In addition, a large amount of nearby electronic devices, including the computer being used, were shown to cause a lot of RFI. Initially, a high pass filter was used to deal with the saturation caused by the line amplifier added. However, in order to mitigate any potential effect of the Millstone Hill Radar and help reduce other RFI sources a 1420-1470 MHz Band Pass Filter was added. Despite the benefits of adding the band pass filter local electrical systems, cabling, and electronics caused a variety of RFI that the filter did not prevent, however, they were all dealt with until the spectrum was clean. Below depicts an example of the RFI being received, see **Figure 10**.

### VIII. DONGLE BASED SRT SCHEMATIC

Now that the major challenges faced while trying to implement the dongle based SRT have been addressed the final schematics for the system can be derived. See **Figure 11**. The overall cost of the new dongle based SRT system was found to be approximately \$691, not including the antenna, antenna motor, antenna motor controller, and the antenna pier. The same system, using the previous SRT designs, was found to be \$3845. This is a total savings of approximately \$3154.

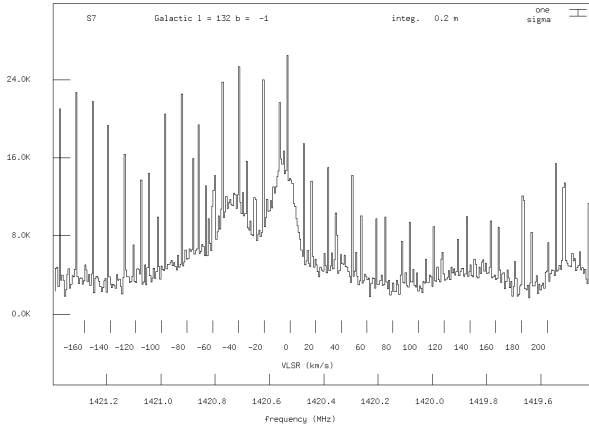

**Figure 10:** Sample spectra containing RFI.

### VII. SYSTEM CALIBRATION

As outlined in Dustin Johnson's paper [2], the method for system calibration for the SRT was repeated for the dongle based SRT. In following with that, the Y-Factor and System temperature were calculated. The Y-Factor can be calculated using:

$$Y = P_H/P_L \tag{1}$$

Repeating the procedure for calibrating the previous SRT,  $P_H$  is the observed power at a high temperature load, which was an absorber assumed to be 300 K.  $P_L$  is the observed power at a low temperature load, which was the cold sky, assumed to be at 3K. The Y-Factor for the dongle based SRT was found to be 2.82, compared to the value of 2.71 for the previous SRT [2]. The system noise temperature can be calculated using:

$$T_{sys} = (T_H - T_L y)/(y - 1) \tag{2}$$

The dongle based SRT had a system temperature of 160.2 K, which is lower than the system temperature of the previous SRT of 170.9 K.

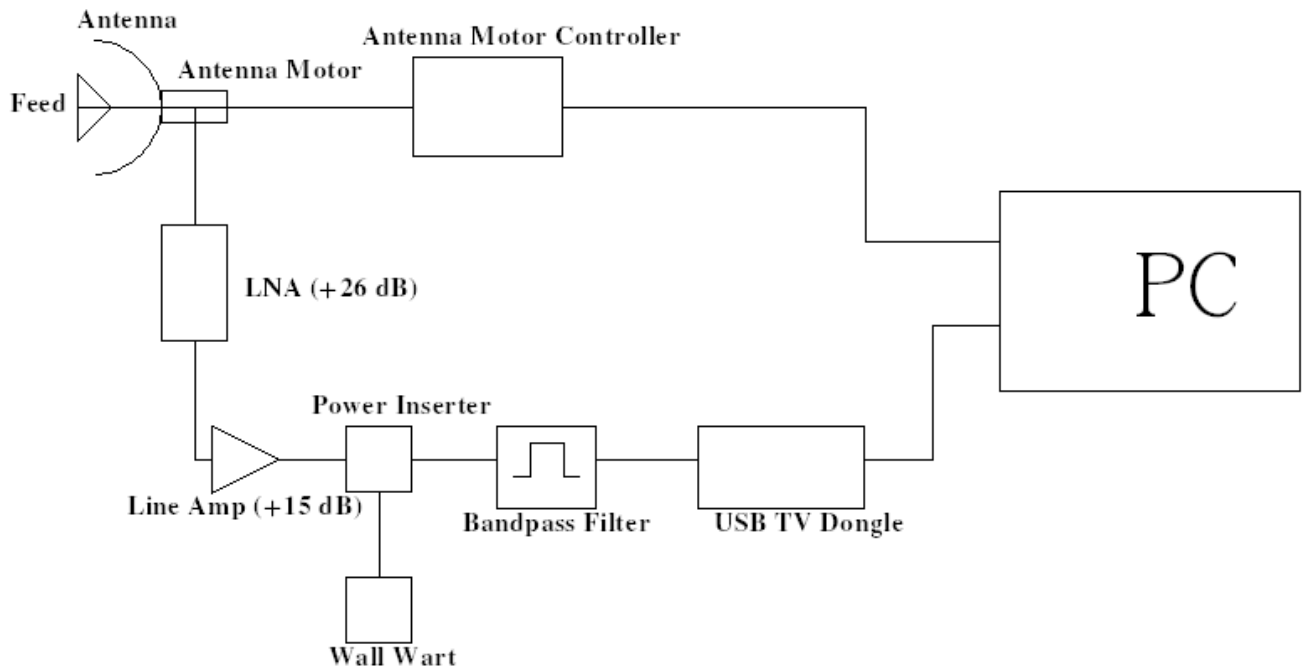

Figure 11: Dongle based SRT schematic.

## IX. ASTRONOMY OBSERVATIONS

In order to test the effectiveness of the system compared to the previous SRT, two astronomy experiments were done:

- Measuring the spectra of several standard regions.
- Measuring the galactic rotation curve.

The results were compared to the experiments done by Dustin Johnson [2] in order to compare the dongle based SRT with the previous SRT more effectively.

### Standard Regions

The spectra of several well known regions of neutral hydrogen emissions have been measured using the SRT developed in the summer of 2012. These hydrogen emissions have been measured using the dongle based SRT. Note the general shape and spectral features of each region instead.

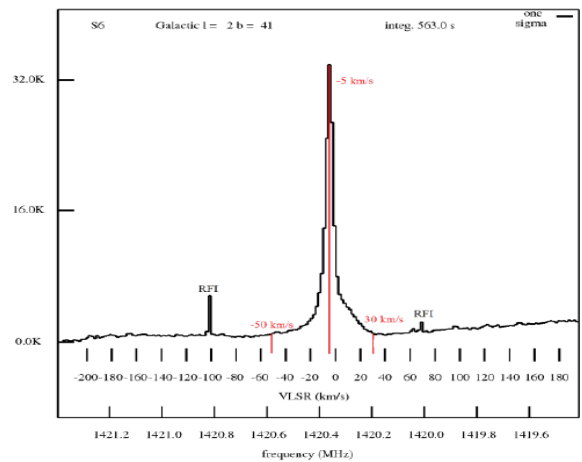

Figure 12: Previous SRT region S6.

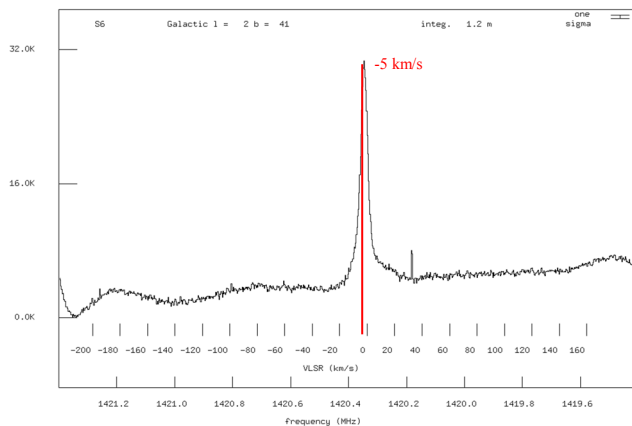

Figure 11: Dongle based SRT region S6.

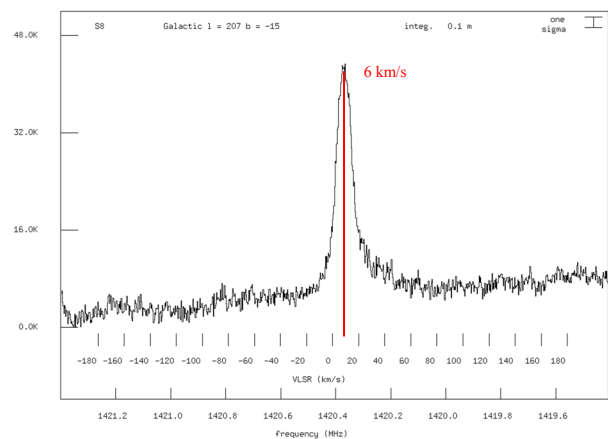
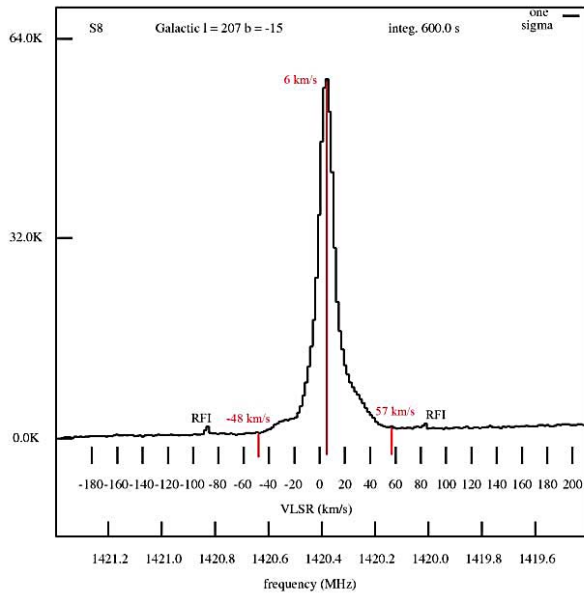

Figure 13: Dongle based SRT region S8.

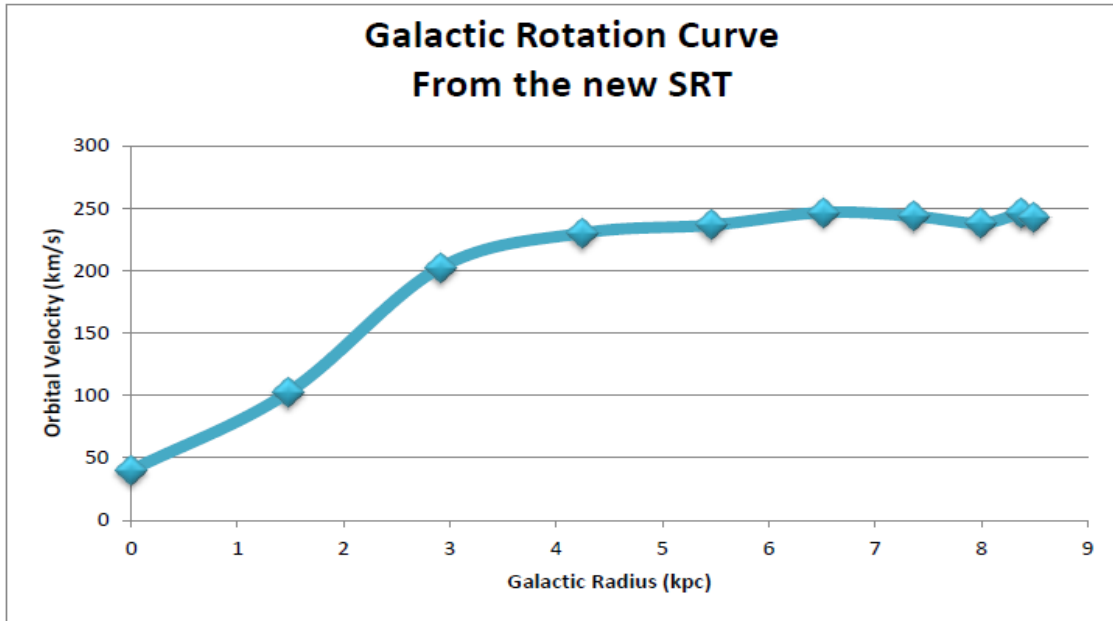

**Figure 14:** Previous SRT region S8.

Shorter integration times were used than that of the previous SRT, which account for increased noise in the general curves of the measurements.

#### *Galactic Rotation Curve*

Another simple experiment that can be done with the SRT is the galactic rotation curve measurement. Following the procedure outlined in [3], several spectra were taken of points along the galactic plane,  $0^\circ$  to  $90^\circ$ . The maximum velocity edge of the observed line, of the  $V_{\text{LSR}}$  velocity, was determined for each point. Then, knowing the orbital velocity of the solar system and its galactic radius, the orbital velocity and galactic radius of each point can be derived. The following results compare the results from Dustin Johnson's galactic rotation measurement with the SRT, **Figure 15**, and results from the dongle based SRT measurement, **Figure 16**.



*Figure 15: Previous SRT galactic rotation curve measurement [2].*

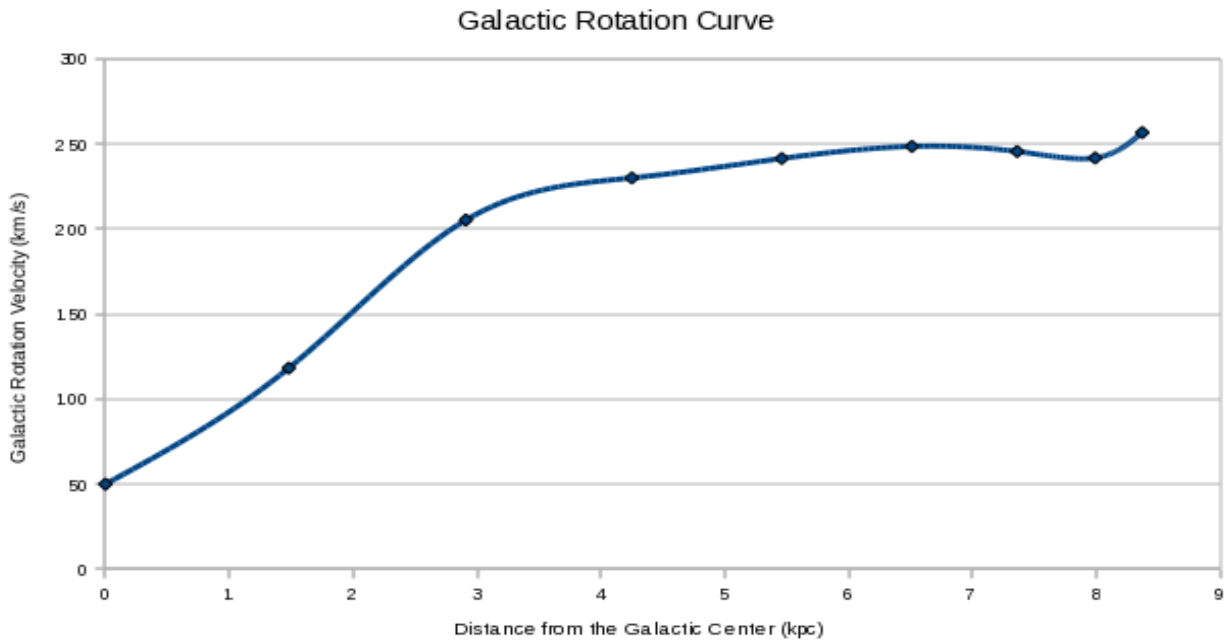

*Figure 16: Dongle based SRT galactic rotation curve measurement.*



Both galactic rotation curves match quite well and have the same general features, such as at 8kpc and the general trend upward and plateau.

#### X. CONCLUSION

The SRT was developed as an educational instrument meant for universities and colleges to learn aspects of radio astronomy and radio technology. The generally high cost and technical overhead associated with making an SRT unit has been a limiting factor since its creation. By leveraging the recent developments in technology, in the form of the USB TV Dongle, the cost of the SRT could be reduced by about \$3154. From the experimentation and characterization done in this paper, it can be concluded that the dongle based SRT system has the potential to be a suitable replacement for the previous SRT system, with the benefit of huge savings, low integration overhead, i.e. all the work is done in software, and its comparable ability to make 21 cm Hydrogen line observations. From the results in this paper, the future replacement of the previous SRT system with a dongle based one seems feasible, in addition, the possibility of replacing both the VSRT and Ozone Spectrometer systems seem reasonable as well.

#### ACKNOWLEDGMENT

I would like to thank Dr. Alan E.E. Rogers, my mentor, for being very patient, helpful, and an overall great mentor. I

would like to thank Mark Derome for helping setup the SRT dish and letting me take over part his office space for a few weeks. Also, I would like to thank Dr. Juha Vierinen for the help he gave me while I was getting started on the project and Timothy Morin for the great IT help he provided. In addition, I would like to thank Dr. Vincent Fish, Dr. Phil Erickson, K.T. Paul, and Heidi Johnson for running a very smooth and great REU program. I would also like to thank the National Science Foundation for providing the opportunity to thank part in this experience.

#### REFERENCES

- [1] Johnson, Dustin. *Haystack Small Radio Telescope Hardware Installation Manual*. MIT Haystack Observatory (2012). Retrieved from: [http://www.haystack.mit.edu/edu/undergrad/srt/pdf%20files/SRT\\_Hardware\\_Manual.pdf](http://www.haystack.mit.edu/edu/undergrad/srt/pdf%20files/SRT_Hardware_Manual.pdf)
- [2] Johnson, Dustin and Dr. Alan E.E. Rogers. "Development of a New Generation Small Radio Telescope." MIT Haystack Observatory (2012). Retrieved from: <http://www.haystack.mit.edu/edu/undergrad/srt/pdf%20files/FinalReport.pdf>
- [3] Ballard, S., Harris, R., Lanz, L., Maruca, B., & Muñoz, D. "Astronomy 218 Haystack Observatory Project Report." Harvard University (2007). Retrieved from: [http://www.haystack.mit.edu/edu/undergrad/pdf/haystack\\_FINAL\\_2\\_8.pdf](http://www.haystack.mit.edu/edu/undergrad/pdf/haystack_FINAL_2_8.pdf)