

# Microstrip, Stripline, and CPW Design

Iulian Rosu, YO3DAC / VA3IUJ, <http://www.qsl.net/va3iul>

In the first years of microwave development the *Rectangular Waveguide* became the dominant waveguide structure largely because high-quality components could be designed using it. One of the main issues was its narrow bandwidth due to the cut-off frequency characteristic.

Later, researchers try to find components that could provide greater bandwidth and possible miniaturization, and therefore they examined other waveguide types.

*Ridge Waveguide* offered a step in that direction, having one or more longitudinal internal ridges that serve primarily to increase transmission bandwidth by lowering the cut-off frequency.

*Coaxial Line* was very suitable, since it possessed a dominant mode with zero cut-off frequency, providing two important characteristics: very wide bandwidth, and the capability of miniaturization. The lack of a longitudinal component of field, made it more difficult to create components using it, although various novel suggestions were put forth. In addition, those components would be expensive to fabricate.

In an attempt to overcome these fabrication difficulties, the center conductor of the coaxial line was flattened into a strip and the outer conductor was changed into a rectangular box, and then fitted with connectors for use with regular coaxial line.

At about the same time, **Robert M. Barrett** when working for the *Air Force Cambridge Research Center* in 1950s took a much bolder step. He removed the side walls altogether, and extended the top and bottom walls sideways. The result was called strip transmission line, or **Stripline**.

Like coaxial cable, Stripline it is non-dispersive, and has no cut-off frequency. Different methods were used to support the center strip, but in all cases the region between the two outer plates was filled with only one single medium, either dielectric material or air.

A modification that emerged almost in the same time involved removing the top plate leaving only the strip and the bottom plate with a dielectric layer between them to support the strip. That structure was named **Microstrip**.

The first Microstrip developments were done shortly after the appearance of Barrett's article, in 1952 by **D.D. Grieg** and **H.F. Engelmann** from the *Federal Telecommunications Laboratories of ITT*, presented as a competing printed circuit line.

Because of the symmetry unbalance in Microstrip, all discontinuity elements possess some resistive content and therefore make the line to radiate to some extent. At that time, regarding this radiation issue, additional remark was attempted to undermine the value of Microstrip line as the basis for microwave components. So, the Microstrip line was compared to an antenna, and it wasn't until about 15 years later, when the *Microstrip Patch Antenna* was proposed, which was based on precisely the same concept.

## Types of Transverse Modes of Electromagnetic Waves

- **TE**, *Transverse Electric* waves, also referred as *H-waves*, are characterized by  $E_z = 0$  and  $H_z \neq 0$  (no *Electric* field in the direction of the propagation). TE waves can be supported inside closed conductors, as well as between two or more conductors.
- **TM**, *Transverse Magnetic* waves, also referred as *E-waves*, are characterized by  $E_z \neq 0$  and  $H_z = 0$  (no *Magnetic* field in the direction of the propagation). Same as TE the TM waves can be supported inside closed conductors, as well as between two or more conductors.
- **TEM** means *Transverse Electromagnetic* mode since both *Electric* and *Magnetic* fields are transverse (perpendicular) to the direction of propagation.  $E_z = H_z = 0$ . TEM mode is also termed a *differential mode*, because the signal current flowing on the inner conductor is directed opposite to the ground current flowing on the outer conductor. The TEM mode has several unique characteristics:
  - At least two unconnected conductors and a single insulating material are required for it to exist.
  - Its cut-off frequency is 0 Hz.
  - It has only two field components (*E* and *H*) aligned with the transverse coordinates, no longitudinal (*z*-directed) *Electric* or *Magnetic* field component.
  - Its propagation constant is the wavenumber in vacuum multiplied with the square root of the relative dielectric constant  $\epsilon_r$  of the insulator.
  - In TEM mode, because of the symmetry of the structure, all discontinuity elements in the plane of the center strip are purely reactive.
- **Quasi-TEM** (Hybrid mode) has non-zero *Electric* and *Magnetic* fields in the direction of propagation. Hybrid modes are higher order modes with cut-off frequencies different from DC (0 Hz) and are undesirable. These modes are a combination of both, the transverse electric (TE) and transverse magnetic (TM) modes and thus have the longitudinal components of both, the electric and the magnetic fields. The wave propagates in two different medias (air and dielectric) in a hybrid mode.

## Planar Transmission Lines

One of the most commonly used transmission lines are the planar types which can be constructed precisely using low-cost printed circuit board materials and processes. A number of these open, multiconductor transmission lines comprise a solid dielectric substrate having one or two layers of metallization, with the signal and ground currents flowing on separate conductors.

Planar transmission lines used in microwave frequencies can be broadly divided into two categories: those that can support a TEM (or Quasi-TEM) mode of propagation, and those that cannot. For TEM (or Quasi-TEM) modes the determination of characteristic impedance and phase velocity of single and coupled lines reduces to finding the capacitances associated with the structure, and also the conductor loss can be determined in terms of variation of the characteristic impedance.

## Skin Depth of Planar Conductors

At high frequencies, the current flowing in a conductor tends to get confined near the outer surface of the conductor. The higher the frequency, the greater the tendency for this effect to occur.

- The skin depth of a conductor is defined as the distance in the conductor (along the direction of the normal to the surface) in which the current density drops to 37% of its value at the surface (the current decays to a negligible value in a distance of about 4 to 5 skin depths).
- The skin depth of perfect inductor (with *Conductivity*  $\sigma = \infty$ ) is zero.
- The conductivity of normal metals (which are used in conductors) is high, although finite, so the skin depth is therefore very small at microwave frequencies.
- The frequency where the skin effect just starts to limit the effective cross sectional area of the conductor (equal to half the thickness of the trace) is called the crossover frequency.
- Skin depth is inversely proportional to the square root of the frequency.
- Skin depth does not depend on the shape of the conductor. Skin depth is a distance measured in from the surface of the conductor toward the center of the conductor.
- If skin depth is deeper than the center of the conductor, the current is not limited by the skin effect and the current is flowing uniformly throughout the entire cross sectional area of the conductor. Therefore, a thicker conductor is limited by the skin effect at a lower frequency than is a thinner conductor.
- The skin effect, by changing the effective cross sectional area of a conductor, causes the effective resistance of the conductor to change with frequency.
- The skin effect is one of the two primary causes of losses in lossy planar transmission lines (the other is dielectric losses.)

## Stripline Design

Stripline requires three layers of conductors where the internal conductor is commonly called the “hot conductor,” while the other two, always connected at signal ground, are called “cold” or “ground” conductors. The hot conductor is embedded in a homogeneous and isotropic dielectric, of dielectric constant “ $\epsilon_r$ ”. So, unlike the case of Microstrip, the word “substrate” is not appropriate since the dielectric completely surrounds the hot conductor.

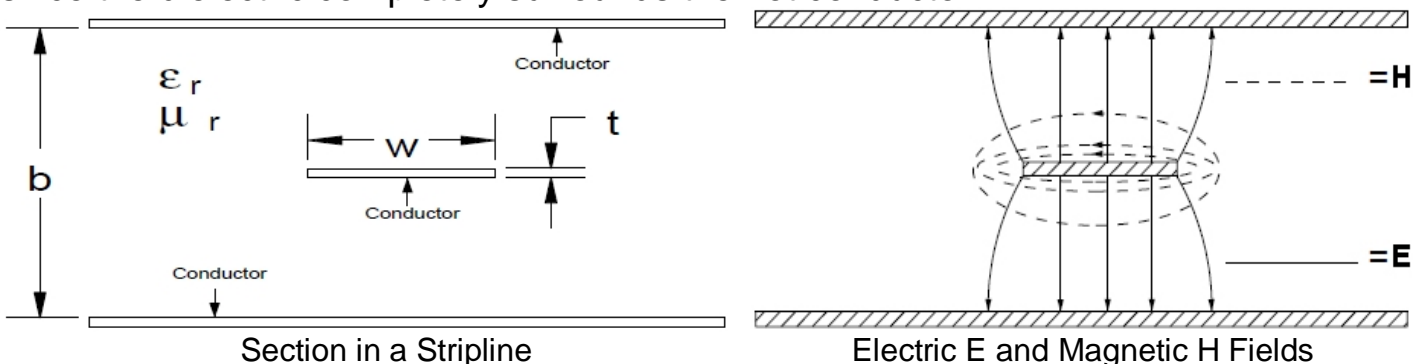

The *Electric-E* and *Magnetic-H* field lines for the fundamental TEM mode in Stripline are indicated above in a defined cross-section and a defined time.

- Because the region between the two outer plates of Stripline contains only a single medium, the phase velocity and the characteristic impedance of the dominant mode TEM do not vary with frequency.
- In the fundamental mode the hot conductor is *equipotential* (every point in it is at the same potential).

Stripline is often required for multilayer circuit boards because it can be routed between the layers, but grounding the Stripline requires some care. If the top and bottom ground planes are not at the same potential, a parallel-plate mode can propagate between them.

If excited, this mode will not remain confined to the region near the strip, but will be able to propagate wherever the two ground planes exist.

- Stripline is more insensitive than Microstrip to lateral ground planes of a metallic enclosure, since the electromagnetic field is strongly contained near the center conductor and the top–bottom ground planes.
- As can be seen from the figure, in a Stripline the return current path for a high frequency signal trace is located directly above and below the signal trace on the ground planes. The high frequency signal is thus contained entirely inside the PCB, minimizing emissions, and providing natural shielding against incoming spurious signals.

In the figure below, the parallel-plate mode is suppressed with metalized via holes connecting the two ground planes. The vias should be placed closely; a spacing “s” of one-eighth of a wavelength in the dielectric is recommended to prevent a potential difference from forming between the ground planes. In addition, such vias form a cage around the strip, in essence making it a basic coaxial line.

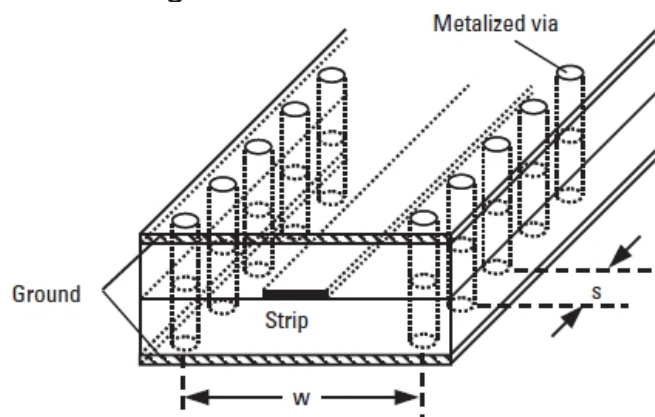

- When the vias are placed too close to the edge of the strip, they can perturb its characteristic impedance.
- The vias separation “w” should be a minimum of 3 strip widths, and 5 is preferable.
- If the via separation is too great, a pseudo rectangular waveguide mode can be excited. This mode has a cut-off frequency given by  $c/(2*w)$ , where  $c$  is the speed of light in the dielectric. Thus, at the highest frequency of operation,  $f_{max}$ , the via separation  $w$  should be less than  $c/(2*f_{max})$ .

- Any practical Stripline has three **Sources of Attenuation**, due to:
    - Finite conductivity of its conductors.
    - Finite resistivity and dumping phenomena of the dielectric.
    - Magnetic resonances.
  - Total power losses per unit axial length are the sum of dielectric loss and the conductor ohmic skin loss.
  - The dielectric loss is proportional to frequency, and it is the dominant loss factor at higher frequencies.
  - The ohmic skin losses in the strip conductor and the ground plane, depend on the conductivity of the metal conductors and on any surface roughness may be caused in fabrication of the transmission line.
- Conductor losses dominate over dielectric losses for loss tangent ( $\tan\delta$ ) less than 0.001 (for  $f = 10$  GHz) and less than 0.003 (for  $f = 1$  GHz).

The **Characteristic Impedance**  $Z_0$  of the Stripline depends on the dielectric constant and on the cross-sectional geometry of the strip center-conductor and ground planes.

- Characteristic impedance is very sensitive to the ratio of center-conductor width to dielectric thickness and relatively insensitive to the ratio of center-conductor thickness to dielectric thickness.
- Mechanical tolerances would be most critical for relatively thin dielectrics or relatively narrow center conductors. Any vertical asymmetry in the Stripline structure could couple to waveguide-type modes bounded by the ground planes and the side walls.

The following is a simple equation that approximates Stripline impedance with 1% accuracy:

$$Z_0 = \frac{30\pi}{\sqrt{\epsilon_r}} \frac{b}{W_e + 0.441b} (\Omega)$$

where  $W_e$  is the effective width of the center strip conductor given by:

$$\frac{W_e}{b} = \frac{W}{b} - \begin{cases} 0 & \text{for } \frac{W}{b} > 0.35 \\ (0.35 - W/b)^2 & \text{for } \frac{W}{b} < 0.35 \end{cases}$$

- It is seen that the characteristic impedance of the Stripline decreases as the strip width  $W$  increases.
- The **Propagation Delay** for a given length in a Stripline is only function of the dielectric  $\epsilon_r$ :

$$t_{pd} (\text{ns/ft}) = 1.017\sqrt{\epsilon_r}$$

## Microstrip Design

The Microstrip line it has become the best known and most widely used planar transmission line for RF and Microwave circuits. This popularity and widespread use are due to its planar nature, ease of fabrication using various processes, easy integration with solid-state devices, good heat sinking, and good mechanical support.

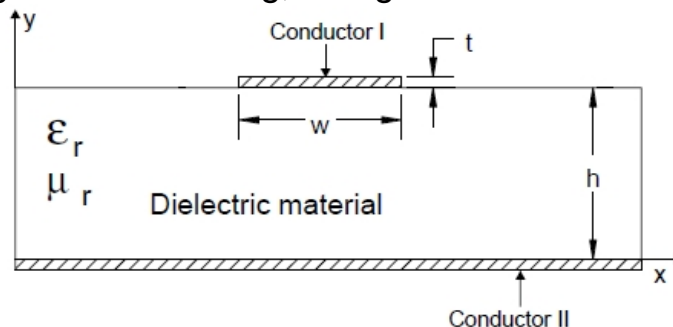

- In simple terms, Microstrip is the printed circuit version of a wire over a ground plane, and thus it tends to radiate as the spacing between the ground plane and the strip increases. A substrate thickness of a few percent of a wavelength (or less) minimizes radiation without forcing the strip width to be too narrow.
- In contrast to Stripline, the two-media nature (substrate discontinuity) of Microstrip causes its dominant mode to be hybrid (Quasi-TEM) not TEM, with the result that the phase velocity, characteristic impedance, and field variation in the guide cross section all become mildly frequency dependent.
- The Microstrip line is dispersive. With increasing frequency, the effective dielectric constant gradually climbs towards that of the substrate, so that the phase velocity gradually decreases. This is true even with a non-dispersive substrate material (the substrate dielectric constant will usually fall with increasing frequency).
- In Microstrip development a new concept of **Effective Dielectric Constant**  $\epsilon_{eff}$  was introduced, which takes into account that most of the electric fields are constrained within the substrate, but a fraction of the total energy exists within the air above the board.
- The Effective Dielectric Constant  $\epsilon_{eff}$  varies with the free-space wavelength  $\lambda_0$ . The dispersion becomes more pronounced with the decreasing ratio of strip width to substrate thickness,  $W/h$ . Dispersion is less pronounced as the strip width becomes relatively wider, and the Microstrip line physically starts to approach an ideal parallel-plate capacitor. In this case we get:  $\epsilon_r \sim \epsilon_{eff}$
- The Effective Dielectric Constant  $\epsilon_{eff}$  is expected to be greater than the dielectric constant of air ( $\epsilon = 1$ ) and less than that of the dielectric substrate.

$$\epsilon_{eff} = \frac{\epsilon + 1}{2} + \frac{\epsilon - 1}{2} \frac{1}{\sqrt{1 + 12h/W}}$$

In this expression shielding is assumed to be far enough from the Microstrip line.

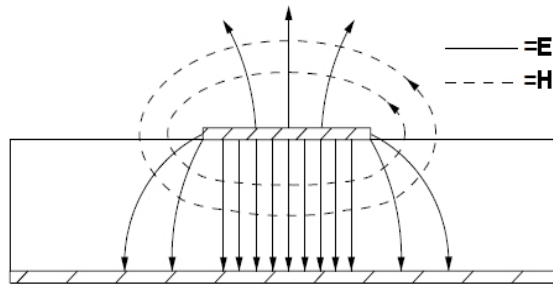

Electric  $E$  and Magnetic  $H$  field lines for fundamental Quasi-TEM in Microstrip

- Effective Dielectric  $\epsilon_{eff}$  can be obtained by static capacitance measurements.
  - If the static capacitance per unit length is  $C$  with partial dielectric filling, and  $C_0$  with dielectric removed, we get  $\epsilon_{eff} = C/C_0$ .
- *Guided Wavelength* in Microstrips is given by:
 
$$\lambda_0 / \sqrt{\epsilon_{eff}}$$
 where  $\lambda_0$  is the wavelength in free space
- The same as in Stripline case, in Microstrip fundamental mode the top conductor is *equipotential* (every point in it is at the same potential).
- A simple but accurate equation for Microstrip **Characteristic Impedance** is:

$$Z_0 = \frac{60}{\sqrt{\epsilon}} \ln \left( \frac{8h}{W} + \frac{W}{4h} \right) (\Omega) \quad \text{for } \frac{W}{h} \leq 1$$

$$Z_0 = \frac{120\pi}{\sqrt{\epsilon} \left[ \frac{W}{h} + 1.393 + 0.667 \ln \left( \frac{W}{h} + 1.444 \right) \right]} (\Omega) \quad \text{for } \frac{W}{h} \geq 1$$

- The characteristic impedance of the Microstrip line changes slightly with frequency (even with a non-dispersive substrate material).  
The characteristic impedance of non-TEM modes is not uniquely defined, and depending on the precise definition used, the impedance of Microstrip either rises, falls, or falls then rises with increasing frequency.  
The low-frequency limit of the characteristic impedance is referred to as the **Quasi-static Characteristic Impedance**, and is the same for all definitions of characteristic impedance.
- Microstrip frequency limitation is given mainly by the lowest order transverse resonance, which occurs when width of the line (plus fringing field component) approaches a half-wavelength in the dielectric. Have to avoid using wide lines.
- For very wide lines, the fields are almost all in the substrate, while narrower lines will have proportionally more field energy in air.
- **Propagation Delay** for a given length in a Microstrip line is only function of  $\epsilon_r$ :
 
$$t_{pd} (\text{ns/ft}) = 1.017 \sqrt{0.475 \epsilon_r + 0.67}$$
- Any practical Microstrip line has following **Sources of Attenuation**, due to:
  - Finite conductivity of the line conductors.
  - Finite resistivity of the substrate and its dumping phenomena.
  - Radiation effects.
  - Magnetic loss plays a role only for magnetic substrates, such as ferrites.

- Waveguides and Striplines have no radiation losses, while in Microstrip case (since the Microstrip is an open transmission line) radiation effects are present at any discontinuity section.
- For Microstrip using high dielectric materials  $\epsilon_r$  and accurate conductor shape and matching, conductor and dielectric losses are predominant in relation to the radiation losses.
- In practice, it has been found that the Microstrip impedance with finite ground plane width ( $Z_o$ ) is practically equal to the impedance value with infinite width ground plane ( $Z_i$ ), if the ground width  $W_g$  is at least greater than  $3 \cdot W$ .

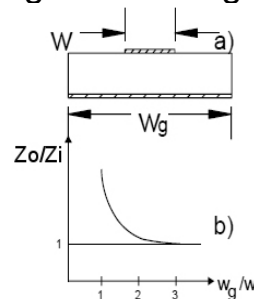

Microstrip's primary advantages of low cost and compact size are offset by its tendency to be more lossy than Coaxial Line, Waveguide, and Stripline.

- **Radiation Losses** depend on the dielectric constant, substrate thickness, and the circuit geometry.
- The lower the dielectric constant, the less the concentration of energy in the substrate region, and, hence, the greater the radiation losses.
- The real benefit in having a higher dielectric constant is not only reducing radiation losses but also that the package size decreases by approximately the square root of the dielectric constant.
- One way to lower the loss of Microstrip line is to suspend the substrate over the air:

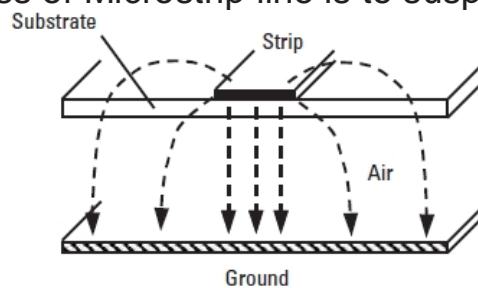

The air between the bottom of the substrate and the ground plane contains the bulk of the electromagnetic field. The insertion loss of the Microstrip is reduced because, air essentially has no dielectric loss compared to standard circuit board substrates, and in addition, the width of the Microstrip line increases because of the lower effective dielectric constant. Wider lines have lower current density, and thus, lower ohmic loss.

- Suspending Microstrip means that the separation between the signal and ground paths increases, and so does the Microstrip's tendency to radiate, particularly at discontinuities such as corners. From this reason, suspended Microstrip mostly is used only up to a few GHz.



- In a Microstrip line, conductor losses increase with increasing characteristic impedance due to the greater resistance of narrow strips. Conductor losses follow a trend that is opposite to radiation loss with respect to  $W/h$ .
- Important to remember, a smaller strip width leads to higher losses.
- Very simple method for measuring the **Dielectric Attenuation** constant is based on the *Comparison Technique*.
  - Two Microstrip lines with identical electrical characteristics but different lengths are used.
  - Their insertion losses are measured.
  - The difference between two values of insertion loss is used to evaluate the dielectric attenuation constant.
  - This procedure avoids the systematic errors caused by radiation and coaxial-to-microstrip transitions.
- The **Power Handling** capacity of a Microstrip is limited by heating caused because of ohmic and dielectric losses and by dielectric breakdown. An increase in temperature due to conductor and dielectric losses limits the *Average Power* of the Microstrip line, while the breakdown between the strip conductor and ground plane limits the *Peak Power*.

A metallic enclosure is normally required for most Microstrip circuit applications, such as Microstrip Filters. The presence of conducting top and side walls will affect both, the characteristic impedance  $Z_c$  and the effective dielectric constant  $\epsilon_{eff}$ .

- In practice, a rule of thumb may be applied in the Microstrip Filter design to reduce the effect of metallic enclosure: the height up to the cover should be more than eight times the substrate thickness, and the distance to walls more than five times the substrate thickness.

## Coplanar Waveguide (CPW) Design

**Coplanar Waveguide (CPW)** is an alternative to Microstrip and Stripline that place both, the signal and ground currents on the same layer.

- **Cheng P. Wen** is the inventor of Coplanar Waveguide in 1969, when working at RCA's Sarnoff Laboratories. The initial paper he published was: "Coplanar Waveguide: a surface strip transmission line suitable for nonreciprocal gyromagnetic device applications".
- The conductors formed a center strip separated by a narrow gap from two ground planes on either side. The dimensions of the center strip, the gap, the thickness and permittivity of the dielectric substrate determined the effective dielectric constant, characteristic impedance and the attenuation of the line.
- The gap in the coplanar waveguide is usually very small and supports electric fields primarily concentrated in the dielectric. With little fringing field in the air space, the

coplanar waveguide exhibits low dispersion. In order to concentrate the fields in the substrate area and to minimize radiation, the dielectric substrate thickness is usually set equal to about twice the gap width.

- CPW has a zero cut-off frequency (suitable for wideband), but its low order propagation mode is indicated with Quasi-TEM because it is not a real TEM mode. At higher frequencies, the field becomes less-TEM, and more TE in nature. The CPW magnetic field is elliptically polarized.
- CPW it is a printed circuit analogs of the three-wire transmission lines.

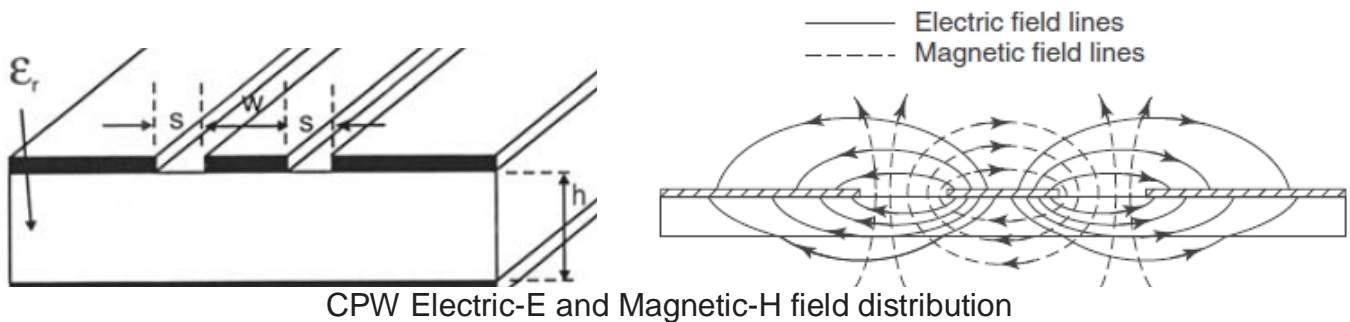

- Like Stripline, CPW has two ground planes, which must be maintained at the same potential to prevent unwanted modes from propagating.
- If the grounds are at different potentials, the CPW mode will become uneven, with a higher field in one gap than the other.
- In the CPW two fundamental modes are supported: the coplanar mode, and the parasitic slotline mode. Air bridges between ground planes have to be applied to suppress the undesired slotline mode.
- If bond wires are used to connect the ground planes the wires should be spaced one quarter wavelength apart or less.

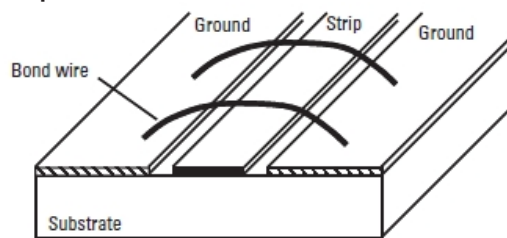

- In the CPW, the effective dielectric constant is approximately independent of geometry, and simply equal to the average of dielectric constants of air and the dielectric substrate.
- Frequency dispersion for CPW is generally small, but there is a mild dependence on line dimensions, and narrow lines are less frequency dispersive than wide lines.
- **Grounded Coplanar Waveguide (GCPW)** is used on printed circuit boards as an alternative to Microstrip line. The gap  $s$  between the strip and ground is usually more than the thickness  $h$  of the substrate, so the GCPW field is concentrated between the strip and the substrate ground plane, and GCPW behaves like Microstrip. With vias connecting the ground planes, GCPW is less prone to radiate and has higher isolation than Microstrip.

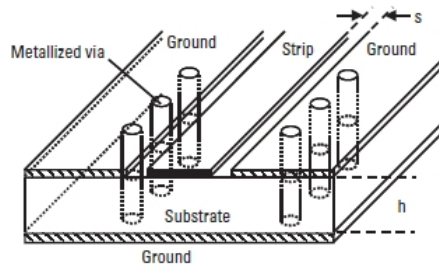

- Since the number of the electric and magnetic field lines in the air is higher than the number of the same lines in the Microstrip case, the effective dielectric constant  $\epsilon_{eff}$  of CPW is typically 15% lower than the  $\epsilon_{eff}$  for Microstrip, so the maximum reachable characteristic impedance values are higher than the Microstrip values.
- The effect of finite dielectric substrate is almost ignorable if  $h$  exceeds  $2b = W+2s$ .
- In addition, to avoid field radiation in the air, it is very important to use substrates with a high dielectric constant, with recommended values greater than 10, so that the electromagnetic field is mainly concentrated inside the dielectric.
- In CPW a ground plane exists between any two adjacent lines, hence cross talk effects between adjacent lines are very weak. As a result, CPW circuits can be made denser than conventional Microstrip circuits.

As other planar transmission lines the **CPW losses** are due to multiple causes:

- Non-perfect conductivity of the conductors, or “conductor loss”.
- Dielectric nonzero conductivity and dumping phenomena.
- Substrate magnetic loss, if the substrate is a ferromagnetic material.
- Radiation.
- CPW is not very sensitive to substrate thickness and allows a wide range of impedance values ( $20\Omega$  - $250\Omega$ ) on relatively thick substrates.
- Upper metal cover has no effect upon characteristic impedance if space  $H > 2h$ .

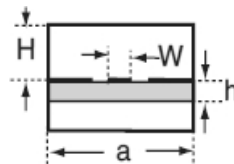

When this limit is exceeded, the effect of the cover will be to lower characteristic impedance.

- Spurious modes (notably the Microstrip mode) can easily be generated if the separation between the CPW structure and the backing metallization is too close (resulting in field lines between the CPW and the backing metallization).
- In CPW the characteristic impedance is determined by the ratio of the centre strip width  $W$  to the gap width  $s$ , so size reduction is possible without limit, the only penalty being higher losses. This makes the design of a CPW line with particular impedance unique because an infinite range of  $W$  and  $s$  values will result in a specific impedance requirement.
- For given characteristic impedance  $Z_0$  and substrate thickness, the strip width  $W$  will always be significantly less than for the corresponding Microstrip, in order to maintain the same capacitance to ground. Therefore, the resistive loss for the CPW line can exceed that of the corresponding Microstrip.

## Microstrip Discontinuities

Surface waves are electromagnetic waves that propagate on the dielectric interface layer of the Microstrip. The propagation modes of surface waves are practically TE and TM. Due to the practical homogeneity of the Stripline dielectric, this phenomenon can be neglected in Stripline devices and so, this section is pertinent to Microstrip lines only.

- Surface waves are generated at any discontinuity of the Microstrip. Once generated, they travel and radiate, coupling with other Microstrip of the circuit, decreasing isolation between different networks and signal attenuation. Surface waves are a cause of crosstalk, coupling, and attenuation in a multi-microstrip circuit. For these reasons the surface waves are always an undesired phenomenon.
- Surface wave propagation may be reduced by cutting slots into the substrate surface just in front of an open-circuit.
- Similar to the case of radiation, surface waves are not guided by the Microstrip.
- Various techniques may be adopted to reduce radiation:
  - Metallic shielding or 'screening.
  - The introduction of a small specimen of lossy (i.e. absorbent) material near any radiative discontinuity.
  - The utilization of compact, planar inherently enclosed circuits (spurline filter).
  - Reduce the current densities flowing in the outer edges of any metal sections and concentrate currents towards the centre and in the middle of the Microstrip.
  - Possibly shape the discontinuity in some way to reduce the radiative efficiency.
- A discontinuity in a Microstrip is caused by an abrupt change in geometry of the strip conductor, and electric and magnetic field distributions are modified near the discontinuity. The altered electric field distribution gives rise to a change in capacitance, and the changed magnetic field distribution to a change in inductance.

Discontinuities commonly encountered in the layout of practical Microstrip circuits are: *Steps, Open-Ends, Bends, Gaps, and Junctions.*

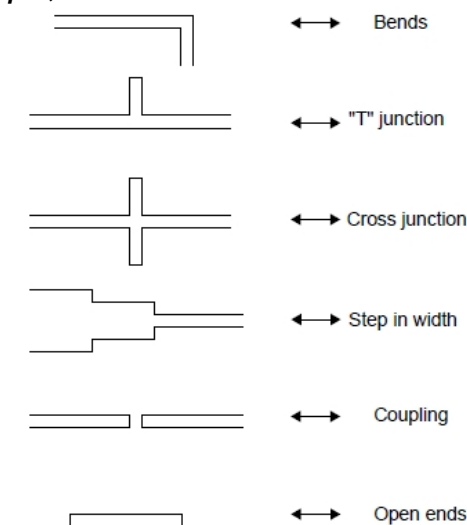

Typical Microstrip Discontinuities

- It is possible to reduce the parasitic effects associated with Open-Ends, Steps, Bends, and Junctions by using constant impedance tapers.

a) **Bends** are the most frequently encountered discontinuities.

The simplest bend is the 90° bend. This bend doesn't work well above few GHz, due to a high VSWR. The same holds true for bends with angles  $\alpha$  greater than 90°.

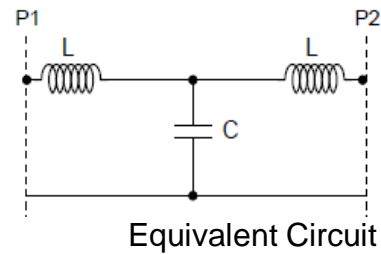
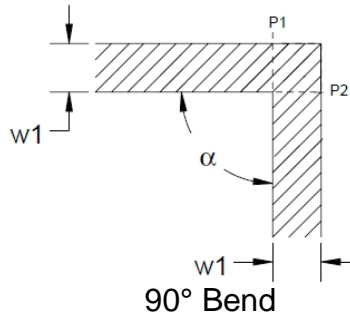

A T-network is the equivalent circuit for a short line length. However, because of the excess capacitance at a square corner the characteristic impedance value will be lower than that of the uniform connecting lines.

- The *Bend Discontinuity Effect* it will increase with frequency, with the number of bends used in cascade, and with the line width.

Compensation for Microstrip corner bend can use either, increased inductance or decrease capacitance techniques.

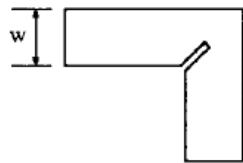

Increased Inductance

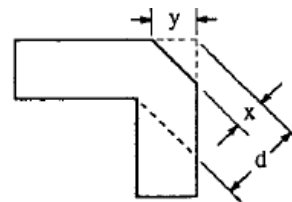

Decreased Capacitance

- Experiments on various bends have proven that a decrease in the input reflection coefficients can be achieved if the corner is chamfered (mitered).

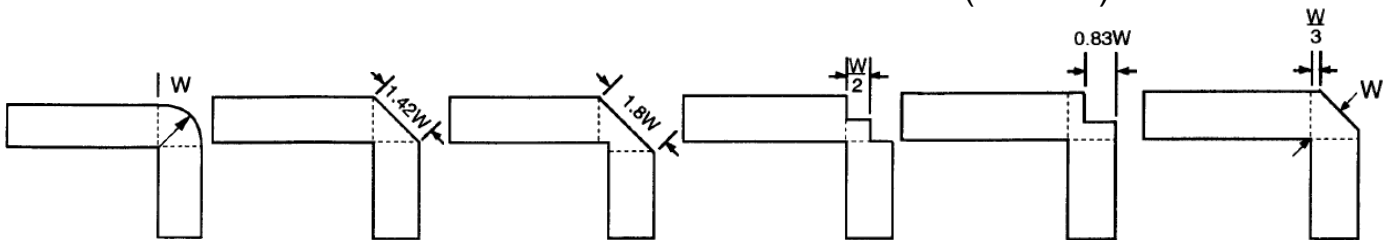

Six different configurations for compensated right-angled bends –  $W$  is the width of the line

The above configurations are applicable for:  $2.5 \leq \epsilon_r \leq 25$ , and  $W/h \geq 0.25$

- Curving a line is frequently a better option than mitering it.

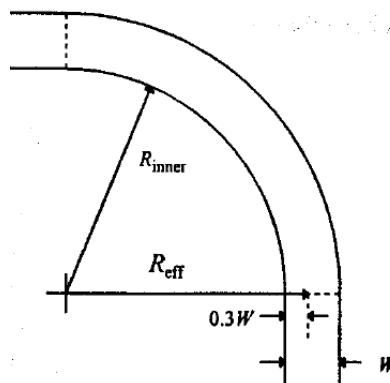

When the curving radius is larger than twice the width of the line, the main parasitic effect is a change in the effective line length. The effective length of the curve ( $3 < R/W < 7$ ) can be estimated by assuming the effective radius to be:

$$R_{\text{eff}} = R_{\text{inner}} + 0.3W$$

Curving a line also has the advantage that the direction of the line can be changed with any arbitrary angle.

- For both, the curved and mitered bends, the electrical length is somewhat shorter than the physical path-length of the Microstrip line.

**b) Open-Ends** are encountered any time a Microstrip is open terminated.

Typical devices where open ends are encountered are *Microstrip Filters* and *Matching Stubs*.

- At the *Open-End* of a Microstrip line with a width of  $w$ , the fields do not stop abruptly, but extend slightly further because of the effect of fringing field. This effect can be modeled either with an equivalent shunt capacitance  $C$ , or with an equivalent length of transmission line  $\Delta l$ .

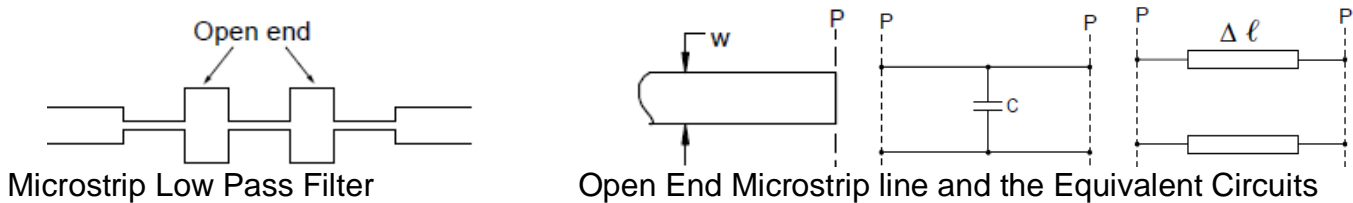

- The simplest way to compensate for the increase in line length is to reduce the length of the designed line by the correct amount.
- A distance of at least the equivalent line length should be allowed between the end of an open-ended stub and the substrate edge.
- For thicker substrates and for wider Microstrip lines, radiation from an *Open-End* discontinuity becomes significant.

**c) Gap Coupling** is a type of discontinuity is can be found in *Microstrip Filters* and in *DC blocks*.

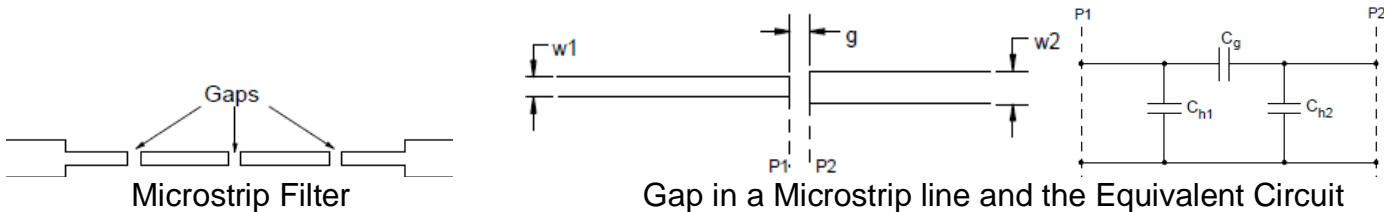

- A *Gap* in a Microstrip line can be equivalently represented as a  $\pi$  capacitor circuit. This circuit between the two reference planes  $P1$  and  $P2$  at each end of the gap consists of a series coupling capacitance  $C_g$ , and two parallel fringing capacitances  $C_{h1}$  and  $C_{h2}$  between the conductor open ends and the ground.
- For narrow gaps,  $C_{h1}$  and  $C_{h2}$  approaches zero and  $C_g$  increases. Practical series capacitance values are approximately 0.01pF to 0.5pF.
- For a very large gap, the capacitance values  $C_g$  approach zero and this discontinuity becomes equivalent to an open-end circuit.

**d) Step Width Junction** discontinuity can be found in many devices: *Matching Networks,  $\lambda/4$  Transformers, multistep  $\lambda/4$  Directional Couplers, Dividers/Combiners, and Microstrip Filters.*

- The parasitic effect of a *Step Junction* is similar to that of an Open-End.
- The effect of the fringing capacitance associated with the wider line of the step discontinuity is similar to an increase in the length of that line.
- The phase shift associated with a step discontinuity will always be less than that caused by an Open-End in a line with the lower characteristic impedance

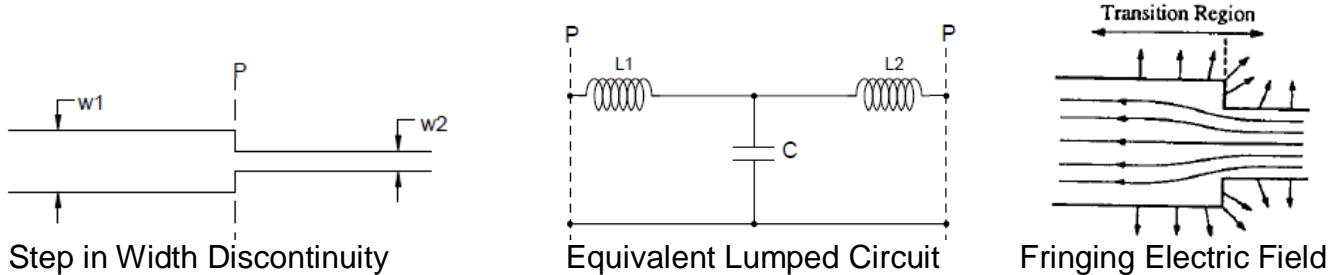

- In terms of distributed elements, the discontinuity capacitance  $C$  has the effect of an increase in length of the wide line  $w_1$ , and an equal decrease in length of the narrow line  $w_2$ .
- To compensate for the excess capacitance, can make the wider line  $w_1$  to be electrically longer by a length  $\Delta l$ .
- Also there is a tapering technique (figure below) applied to reduce the discontinuity effects associated with a step width junction.

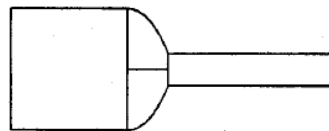

**e) T-Junction** discontinuity is perhaps the most important discontinuity as it is found in circuits as *Impedance Matching Networks, Stub Filters, and Directional Couplers* as “Branch-Line” and “Rat-Race”.

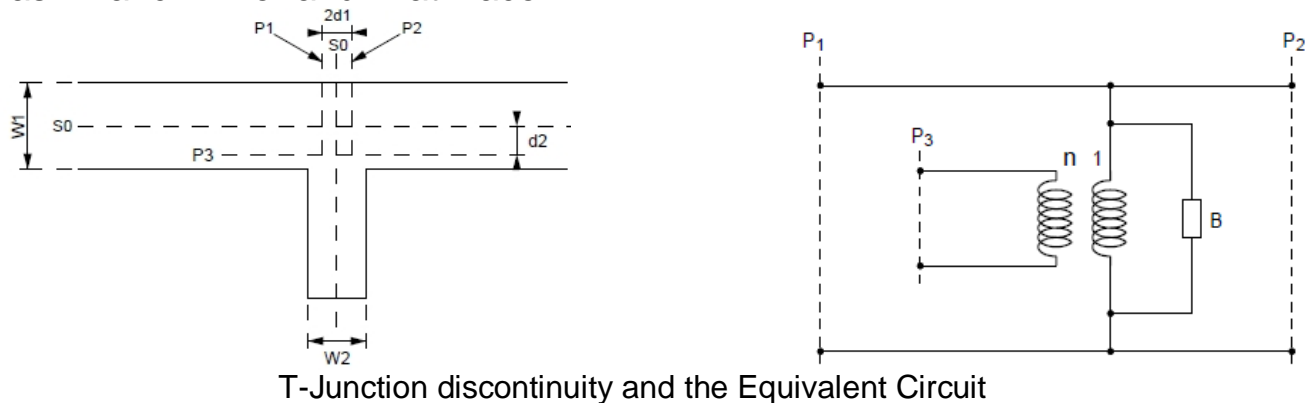

T-Junction discontinuity and the Equivalent Circuit

- T-Junctions can be compensated easily for the reference plane offsets by simply adjusting the lengths of the different lines. The offset in the main line is usually very small, and the main effect is on the length of the stub.

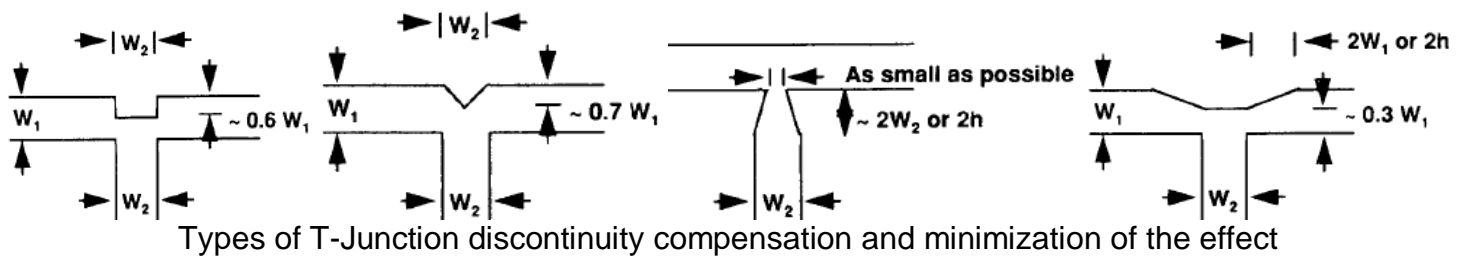

- The best solution to the transformer effect is to keep the width of the stub ( $W_2$ ) narrow enough for the transforming effect to be negligible.

f) **Cross-Junction** discontinuity is mainly found in *Matching Networks* and *Microstrip Notch Filters*.

- As a first order approximation a cross can be considered to be two T-Junctions in parallel.

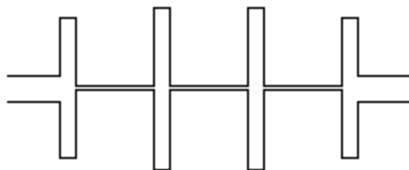

Microstrip Notch Filter using Cross-Junctions

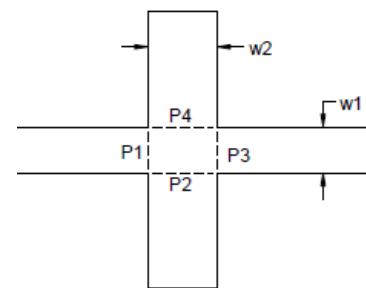

Cross-Junction discontinuity

- One of the most common of Cross-Junction is for the realization of low impedance stubs. When impedance stub has a strip width large enough to sustain transverse resonance modes, one of the possible solutions is to employ two stubs in parallel, connected on either side of the main line. The impedance of each of the equivalent stubs is equal to twice the impedance of the simulated stub.

## Lumped Microstrip Components

Lumped components have the advantage of small size, low cost, and wide-band characteristics, but have lower  $Q$  and lower power handling than distributed elements.

- To function well as a lumped element at microwave frequencies, the length of the equivalent inductor and capacitor elements should not be longer than 12% ( $30^\circ$ ) of a wavelength  $\lambda$ , or they will begin to lose their lumped equivalency effect. Some authors recommend the length should be less than  $\lambda/20$ .
- Lumped inductors and capacitors circuits will only function for that particular dielectric constant, board thickness, and frequency used in the original equivalency calculations.
- Due to Microstrip's electromagnetic field leakage, when shielding Microstrip lumped equivalent capacitors and inductors (as well any Microstrip's transmission lines), the RF shield should be kept at least five substrate thicknesses above the copper, or a disruption within the field, with resulting impedance variations, can occur.



## a) Microstrip Inductors

- The inductance value of a Microstrip inductor is determined from the total length, the number of turns, spacing, and line width.
- Narrow tracks are more inductive but carry less current, so there is a trade-off between them.
- Spiral track inductors have more inductance because the magnetic fields from each turn of the spiral add up, creating a larger field through the middle of the spiral and mutual inductance between all the turns.

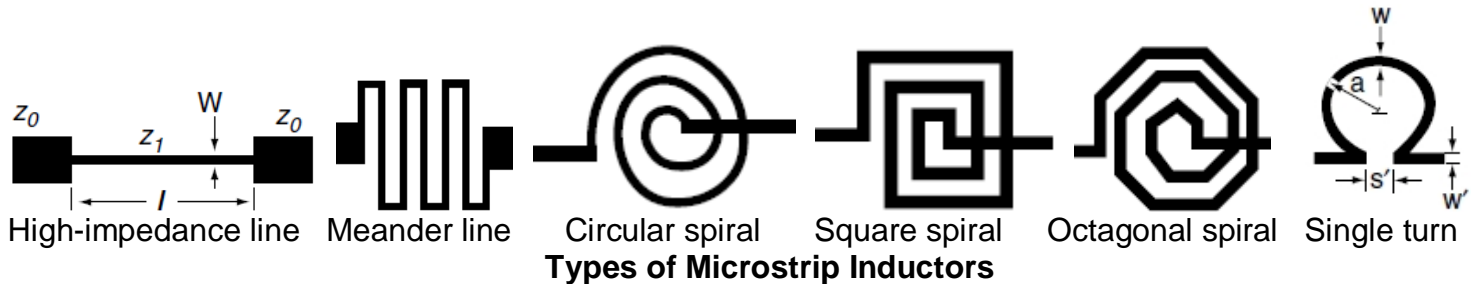

- The high-impedance, ***Straight-line*** section is the simplest form of an inductor, used for low inductance values (typically up to 3 nH), while the spiral inductor (circular or rectangular) can provide higher inductance values, typically up to 10 nH.
- The inductance of an isolated (no ground plane), flat, ribbon inductor (or ***Strip Inductor***) is given approximately by:

$$L \text{ (nH / mm)} = 0.2 \{ \ln[l / (w + t)] + 1.193 + 0.2235(w + t) / l \}$$

where  $w$  is the width of the ribbon,  $t$  is the metal thickness, and  $l$  is length.

- The inductance of a strip inductor is decreased by the presence of a ground plane. The effective inductance of a strip inductor using a ground plane is:

$$L_{\text{eff}} = [0.570 - 0.145 \ln(W / h)] \cdot L$$

where  $h$  is the substrate height.

- The ***Meander-line Inductor*** is used to reduce the area occupied by the element.
- In the meander inductor, adjacent conductors have equal and opposite current flows, which reduce the total inductance.
- Mutual coupling effects are usually small if the spacing is greater than three strip widths. The strip width is much smaller than the substrate thickness.
- Meander-line inductors have the advantage of lower eddy current resistance, but they have lower inductance and lower SRF (self-resonant frequency) than spiral inductors.

Many different types of ***Spiral Inductors*** are used in Microstrip development, such as circular (or square) air bridge cross inductor, octagonal spirals, single-turn spiral, etc.

- Some ***Characteristics and Requirements*** for ***Microstrip Spiral Inductors***:
  - The resistance of spiral inductors depends on frequency because of the skin effect.
  - The *Q-factor* of an inductor depends directly on the inductance.
  - The two most important geometric parameters affecting *Q* are the conductor width-to-spacing ratio and the inductor outside diameter.
  - The *Q-factor* increases with an increase in the outside diameter.
  - For minimum losses, the outer diameter of a spiral inductor should be approximately five times the inner diameter. This ratio of diameters optimizes the *Q* value, but not the maximum inductance value.
  - The *Q-factor* increases as the square root of the frequency due to the skin effect
  - The effect of *Eddy Currents* can be minimized by making the line widths of the inner turns of the inductor narrower than the outer turns. In this structure the improvement in *Q*-value is more pronounced at higher than lower frequencies, because the effect of *Eddy Currents* is more severe at high frequencies.
  - The *Q*-enhancement of planar spiral inductors can also be achieved by using the differential excitation technique. The *Q*-factor of such inductors is enhanced because of smaller substrate loss and is maintained over a broader bandwidth compared to the single-ended configuration.
  - The *Q* of an inductor can be further enhanced by reducing the conductor resistance using thick copper metal.
  - Circular spiral inductors have higher *Q* than rectangular inductors; however, they also have lower inductance for an equivalent area.
  - Parasitic capacitances will cause a spiral inductor to get a self-resonance SRF. The most basic parasitic capacitance is that which is created by the coupling between the turns of the inductor. When a ground plane is under the spiral inductor, we have additional parasitic capacitance between spiral and ground. Introducing a large air gap between the substrate and spiral coils reduce the effect of the substrate on SRF and *Q*-factor, and also will reduce the winding capacitance by spatially separating the spiral coils from the central return lead. This separation is obtained by the air (not by the dielectric material) and the parasitic capacitance can be minimized.
  - The self-resonant frequency SRF must be at least twice the maximum operating frequency for the inductance to have a constant value.
  - To realize high-quality inductors, thicker metal with higher conductivity (e.g., copper and gold) can be used to overcome the series resistive loss.
  - The spiral inductor should have the widest possible line, while keeping the overall diameter small. This implies that the separation between the turns should be as small as possible.
  - The ideal case of the inductor is in free space with no ground plane. Have to take into account the effect of the ground plane, which tends to decrease the inductance value as the ground plane is brought nearer.
  - The inductance of one single-turn of spiral inductor is less (because of the proximity effect) than the inductance of a straight line with the same length and width.

## b) Microstrip Capacitors

- Capacitors are lumped circuit elements that store energy by virtue of electric fields.

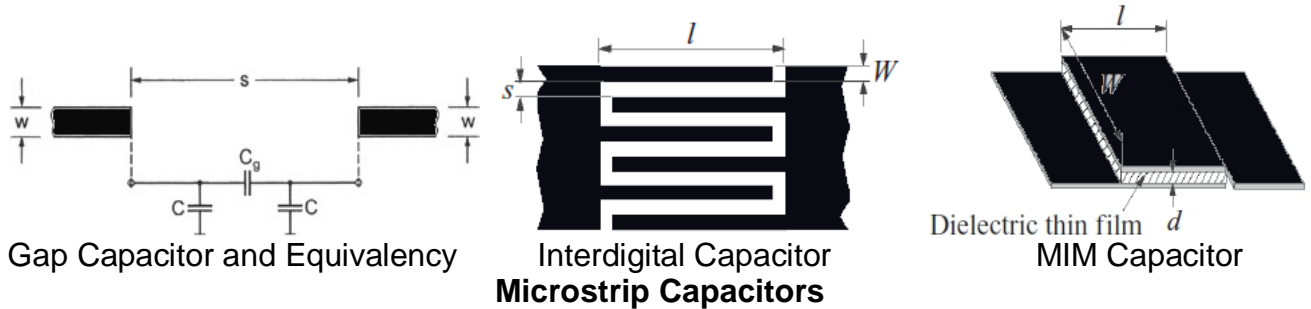

- The **Gap Capacitor** can be described as two coupled open-ended Microstrip lines. The capacitance  $C$  refers to the open-end capacitance and the series gap capacitance  $C_g$  describes the electrical coupling. Up to approximately 20 GHz, the frequency dependence of the equivalent capacitances is negligible. The series gap interrupts the conductive strip of the Microstrip line, and the DC power cannot be transmitted. RF power transfer is accomplished by electrical field coupling. A Gap Capacitor can provide a series capacitance of 0.05pF to 0.5pF.
- The **Interdigital Capacitor** relies on the strip-to-strip capacitance of parallel conducting fingers on a substrate and it's suitable for applications where low values of capacitance (less than 1pF) are required.
  - The finger width  $W$  must equal the space  $s$  to achieve maximum capacitance density, and the substrate thickness  $h$  should be much larger than the finger width.
  - The Interdigital Capacitor relies on the fringing capacitance between the long common edge areas of the metal fingers which are separated by very small spacing depending on the minimum gap allowed by the foundry. The fringing capacitance is fairly low, and as was stated, the capacitors are able to reach small capacitance values, up to 1pF.
  - The Interdigital Capacitor size can be reduced by reducing the dimensions of the structure or by using a high dielectric constant value substrate. Increasing the dielectric constant of the medium a hundred-fold will reduce the component dimensions by a factor of 10.
  - The Q-factor of Interdigital Capacitors can be enhanced by using high-conductivity conductors and low-loss tangent dielectric materials. Other Q enhancement techniques include suspended substrate, multilayer structure, and micromachining.
  - By selecting the proper substrate thickness and air spacing between the substrate and ground plane, one can reduce the capacitor loss by a factor of 25% to 50%.
  - The micromachining approach reduces the parasitic capacitance by a factor of  $\epsilon_r$  and results in better millimeter-wave circuits.
  - The parasitics associated with Interdigital Capacitors can be ignored as long as the Capacitance x Frequency product is smaller than  $2 \times 10^{-3}$

- Fundamental **Parallel-Plate Capacitors** consisting of a pair of parallel planar metallic surfaces separated by a dielectric are available in chip forms as discrete components. The **Metal-Insulator-Metal (MIM) Capacitor**, constructed by using a thin layer of a low-loss dielectric (typically 0.5- $\mu\text{m}$  thick) between two metal plates, is used to achieve higher values, for example, as tens of pF in small areas. The metal plates should be thicker than three skin depths to minimize conductor losses.

The top plate is generally connected to other circuitry by using an air bridge that provides higher breakdown voltages.

The MIM capacitance is given by the classical expression from electrostatics:

$$C = \frac{0.0885 \epsilon W l}{h} \text{ (pF)}$$

where  $\epsilon$  is the dielectric constant,  $W$ ,  $l$ , and  $h$  are dimensions in centimeters.

- When the MIM capacitor value is small, on the order of, say, 0.2 pF, the measured value of capacitance is always larger than the design value based on capacitance per unit area. This is due to the fact that the dielectric thickness along the periphery is thinner than at other places and this effect is more pronounced for smaller capacitor areas.

### c) Quasi-Lumped Microstrip Elements

- Microstrip line short sections and stubs, whose physical lengths are smaller than  $\lambda_g/4$  (quarter of guided wavelength) at which they operate, are the most common components for approximate microwave realization of lumped elements in Microstrip filter structures, and are termed Quasi-Lumped elements. They may also be regarded as lumped elements if their dimensions are even smaller, say smaller than  $\lambda_g/8$ .
- A stub is a length of a straight transmission line that is short or open-circuited at one end and connected to the circuit at the opposite end.

- High- and Low-Impedance Short-Line Sections

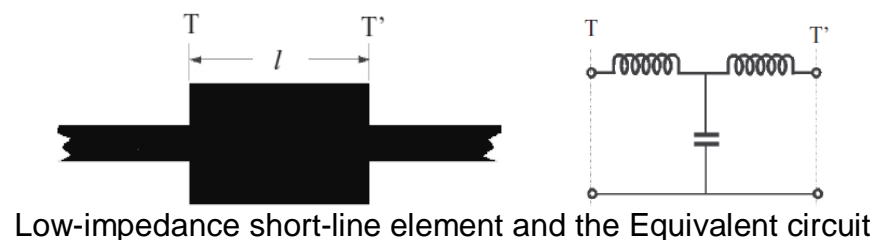
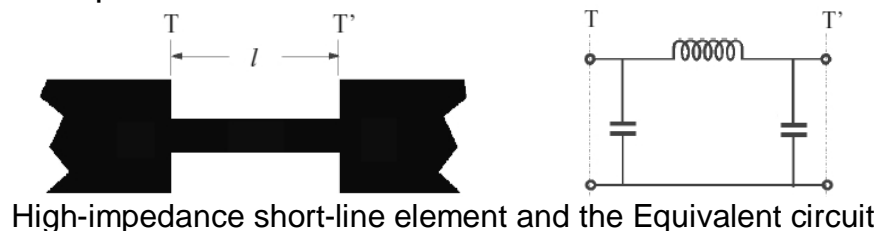

o Open and Short-Circuited Stubs



The  $\lambda_g/4$  stub can be used for many purposes, bypassing or notching certain frequencies.

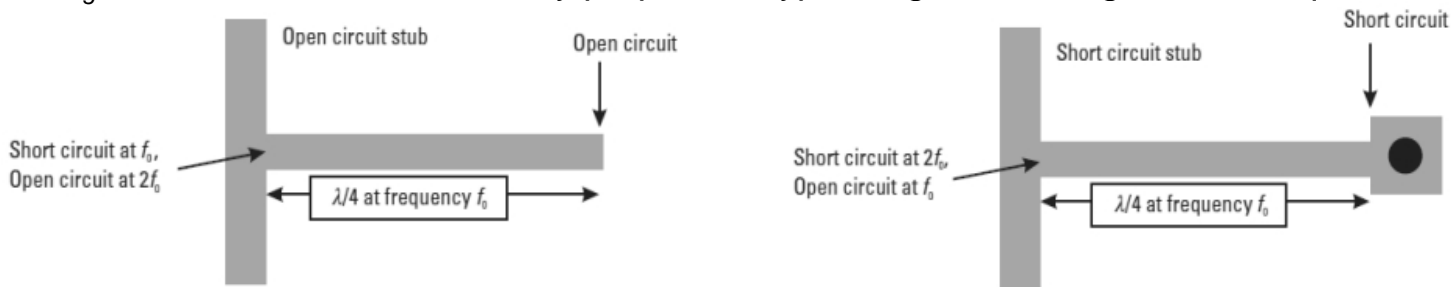

- A  $\lambda_g/4$  stub if it is left with an open-end it can be used as a *Notch Filter* to attenuate certain frequencies. The bandwidth of a  $\lambda_g/4$  Microstrip notch filter is about 20 %. The  $\lambda_g/4$  notch filter will not only attenuate the design frequency but it will also attenuate the frequency band around the odd harmonics of the design frequency.
- $\lambda_g/4$  Microstrip stubs can be used for designing **Bias Networks** to supply DC to microwave diodes, transistors, or RFICs.

A bias injection network is one that is designed to combine both, microwave and low frequency ports.

There should be no low frequency path to the microwave input branch, but the DC input port must also appear as a microwave open circuit at the junction to the through transmission line.

A  $\lambda_g/4$  shunt line stub with a short-circuit termination may be either a true short circuit for a DC ground return or in the form of a capacitive feed-through element. Important is the bandwidth performance of the circuit.

- o Higher impedance stubs (with high ratio  $Z_{\text{stub}}/Z_0$ ) have broader band response.

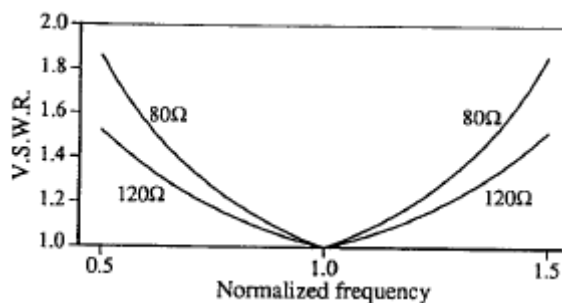

Frequency response of two different impedance stubs

- o An improved DC injection network can be made decreasing the impedance  $Z_0$  at the stub junction (lower the impedance, thicker the line).

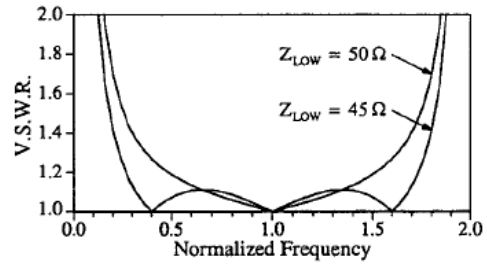
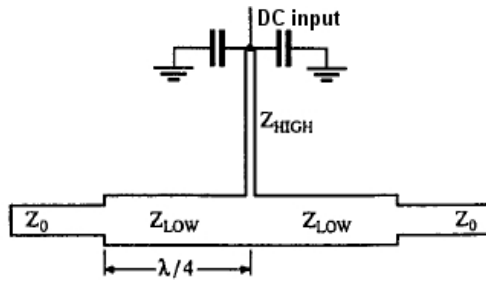

## o Radial Stubs

Radial stub is an open-circuit stub realized in radial transmission line instead of straight transmission line.

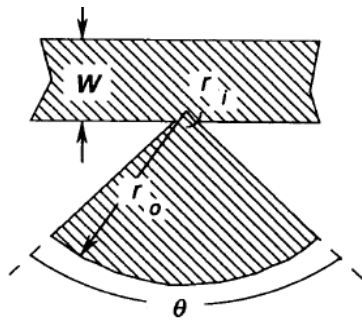

Radial Stub Elements

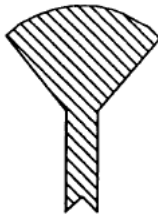

Series Radial Stub



Shunt Radial Stub

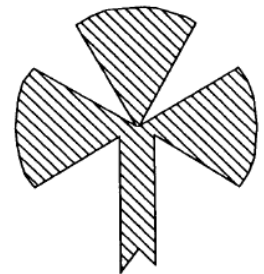

Three 60° Radial Stub

- Radial stub it is a useful element, primarily for providing a clean (no spurious resonances) broadband short circuit, much broader than a simple open-circuit stub. It is special useful on bias lines at high-frequencies.
- Radial stubs are shorter than uniform stubs, they cannot be folded or bent; therefore they take up a lot of substrate area.
- There is no simple equation to describe the radial stub adequately, and practical experiments work better than any formula.
- In the radial shunt configuration (*butterfly radial stub*), the added symmetry of multiple stubs may improve the bandwidth, as well in the three 60° radial stubs case presented in the figure above.

## Microstrip Resonators

- A **Microstrip Resonator** is any structure that is able to contain at least one oscillating electromagnetic field.

Microstrip Resonators may be classified as lumped-element or quasi-lumped-element resonators, and distributed-line resonators or patch resonators.

- **Lumped-Element** or **Quasi-Lumped-Element Resonators**, formed by the lumped or quasi-lumped inductors and capacitors will resonate at  $\omega_0 = 1/\sqrt{LC}$ .

They may resonate at some higher frequencies, at which their sizes are no longer much smaller than a wavelength, and by definition, are no longer lumped or quasi-lumped elements.



Lumped-Element Resonator



Quasi-Lumped-Element Resonator

- The **Distributed-Line Resonators** may be termed as the quarter-wavelength resonators, since they are  $\lambda_{g0}/4$  long, where  $\lambda_{g0}$  is the guided wavelength at the fundamental resonant frequency  $f_0$ . They can also resonate at other higher frequencies.

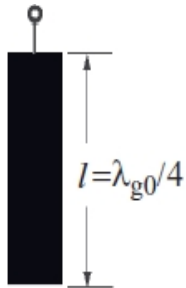

$\lambda_{g0}/4$  Line Resonator (shunt-series -resonance)

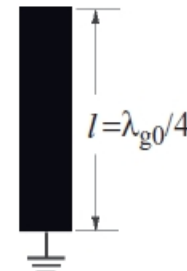

$\lambda_{g0}/4$  Line Resonator (shunt-parallel resonance)

- A  $\lambda_{g0}/4$  short-circuited stub operate as a parallel LC, and the open-circuit stub as a series LC resonator.
- Another typical Distributed-Line resonator is the **Half-Wavelength Resonator**, used in Microstrip filters implementation. This resonator is  $\lambda_{g0}/2$  long at its fundamental resonant frequency, and can also resonate at:  $f \approx nf_0$  for  $n = 2, 3, \dots$

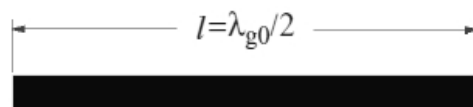

Half-Wavelength Resonator

- The main difficulty with the use of Distributed-Line resonator is caused by the end effects.
- While Microstrip conductor and dielectric dissipation may be expressed as loss per unit length, radiation losses may only be related to specific lengths of line.
- The quality factors  $Q$  of  $\lambda_{g0}/2$  resonators, which include radiation losses, provide a guide to the losses that occur in Microstrip.
- Some slight increase in the quality factor is obtained by using lower  $\epsilon_r$  substrates,  $\tan \delta$  being equal, with resultant larger guide wavelengths, which may be advantageous at higher frequencies.

- The **Ring Resonator** is another type of Distributed-Line resonator, where  $r$  is the median radius of the ring. The ring will resonate at its fundamental frequency  $f_0$  when its median circumference is is:  $2\pi r \approx \lambda_{g0}$ . The higher resonant modes occur at:  $f \approx nf_0$  for  $n = 2, 3, \dots$
- The Microstrip Ring Resonator is a simple transmission line in which resonator is excited at certain frequencies. Depending on the electrical length of the resonance a standing wave pattern forms around the circular path of the resonator. The maximum voltage of the standing wave occurs at the exciting point. The resonant frequencies correspond to a condition where the parameter of the ring is an integer multiple of the guided wavelength.



Ring Resonator

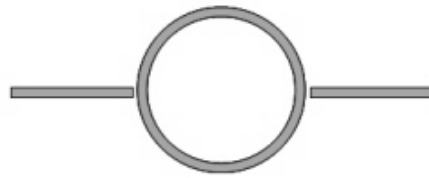

End-Coupling



Edge-Coupling

- The coupling gap is an important part of the ring resonator. It is the separation of the feed lines from the ring that allows the structure to only support selective frequencies. The size of the coupling gap also affects the performance of the resonator. If a very small gap is used, the losses will be lower but the fields in the resonant structure will also be greatly affected. A larger gap results in less field perturbation but greater losses. It is intuitive that the larger the percentage of the ring circumference the coupling region occupies, the greater the effect on the ring's performance.



Ring Resonators Enhanced Coupling Techniques

- At resonant frequencies there exists a voltage maximum at  $\pi d/2$  away from the excitation point. By placing a transmission line at this voltage maximum point, the field in the resonator can be probed to detect the resonance frequencies.
- The dissipated power in the *Ring Resonator* includes the dielectric loss, the conductor loss, and the radiation loss.
- The End-Coupling structure provides a band-pass whenever the ring is a multiple of wavelengths, when the Edge-Coupling technique can be seen on the reflection coefficient ( $S_{11}$ ) of the coupled transmission line whenever the ring is an integer number of wavelengths. The circuit in this case behaves like a band-reject filter, sometimes called a spur line filter.
- The influence of curvature in Ring Resonators becomes large if substrate materials with small relative permittivity and lines with small impedances are used.



Under these conditions the widths of the lines become large and a mean radius is not well-defined. If small rings are used, then the effects become even more dramatic because of the increased curvature.

- The Microstrip Ring Resonator has found applications in determining optimum substrate thickness, discontinuity parameters, effective dielectric constant and dispersion, and loss and Q-measurements.
- When the idea of a Microstrip Ring Resonator was introduced for the first time, also were described techniques used to measure the phase velocity and dispersive characteristics of a Microstrip line by observing the resonant frequency of the ring resonator.

**Determination of the Dielectric Constant** using Microstrip Ring resonators:

- The Microstrip Ring resonator is designed to the certain main resonance frequency and the design is based on an estimated value of dielectric constant.
- Measured values of the main resonance frequency and the harmonic resonance frequencies will differ from designed ones, if difference between the estimated dielectric constant and the actual dielectric constant is appeared.
- Based on the difference of the estimated and the actual dielectric constant, frequency dependent value for dielectric constant can be calculated at each resonance frequency.

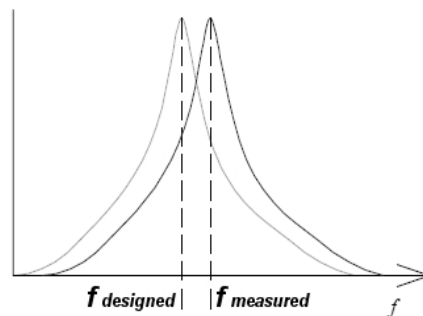

- The main advantage using Microstrip Ring resonators for dielectric and dispersion measurements is that, in contrast to Distributed-Line resonators, no end effects need to be considered.

- **Patch Resonators** are of interest for the design of Microstrip Filters, in order to increase the power-handling capability, and also due to their lower conductor losses as compared with narrow Microstrip line resonators.
  - Because Patch resonators tend to have a stronger radiation, they are normally enclosed in a metal housing for filter applications so that the radiation loss can be minimized.
  - Depending on the applications, patches may take different shapes, such as Circular or Triangular.

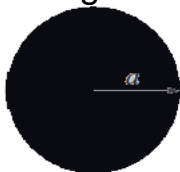

Circular Patch Resonator



Triangular Patch Resonator

## References:

1. *History of Wireless* – T.Sarkar, R.Mailloux, A.Oliner, M.Salazar-Palma, D.Sengupta
2. *Microstrip Filters for RF-Microwave Applications* – Jia-Sheng Hong
3. *Essentials of RF and Microwave Grounding* – E.Holzman
4. *Networks and Devices using Planar Transmission Lines* – Franco Di Paolo
5. *Passive RF and Microwave Integrated Circuits* – L.G.Maloratsky
6. *Microwave Engineering* – D. Pozar
7. *Practical RF Circuit Design for Modern Wireless Systems, - Passive Circuits and Systems* – L.Besser, R.Gilmore
8. *Analysis Methods for RF, Microwave, and Millimeter - Wave Planar Transmission Line Structures-* C.Nguyen
9. *Complete Wireless Design* - C. Sayre
10. *Coplanar Waveguide Circuits, Components, and Systems* - R.Sim
11. *Design of RF and Microwave Amplifiers and Oscillators* – P.Abrie
12. *Determination of the Dielectric Constant* – J.M.Heinola
13. *Foundations of Interconnect and Microstrip Design* – T.C.Edwards, M.B.Steel
14. *High Frequency and Microwave Engineering* - E. da Silva
15. *Maximum Q-Factor of Microstrip Resonators* – A.Gopinath
16. *Microstrip and Stripline Design – Analog Devices*
17. *Microstrip Lines and Slotlines* – K.Gupta, R.Garg, I.Bahl, P.Bhartia
18. *Microstrip Lines* – I.D.Robertson
19. *Microwave Electronics* – L.F.Chen, C.K.Ong, C.P.Neo
20. *Microwave Engineering using Microstrip Circuits* – E.H.Fooks, R.A.Zakarevicius
21. *Microwave Ring Circuits and Related Structures* – K.Chang, L.H.Hsieh
22. *Microwaves Made Simple - The Workbook* – W.S.Cheung, S.Algeri, L.Stark
23. *Modern Microwave Circuits* – N.Kinayman, M.I.Aksun
24. *Planar Circuit Analysis of Microstrip Radial Stubs* – F.Giannini, R.Sorrento, J.Vrba
25. *Planar Microwave Engineering* – T.Lee
26. *Reviewing the basics of Microstrip Lines* – L.G.Maloratsky
27. *RF and Microwave Circuit and Component Design for Wireless Systems* – K.Chang, I.Bahl, V.Nair
28. *RF and Microwave Coupled-Line Circuits* – R.Mongia, I.Bahl, P.Bhartia
29. *RF and Microwave Wireless Systems* – K.Chang
30. *RF Circuits Design - Theory and Applications* – R.Ludwig, P.Bretchko
31. *Skin Effect* – D.Brooks
32. *The RF and Microwave Circuit Design Cookbook* – S.Maas
33. *Transmission Line Design Handbook* – B.Wadel
34. *Microstrip Lines for Microwave Integrated Circuits* - M.Schneider
35. *Microwave Engineering using Microstrip Circuits* – E.Fooks, R.Zakarevicius
36. *Lumped Elements for RF and Microwave Circuits* – I.Bahl
37. *Microwave Journal Magazine* – 1996 – 2012
38. *Microwaves & RF Magazine* – 2002 – 2012
39. *High Frequency Electronics Magazine* – 2002 - 2011